



www.ffcrelax.com

**6th Conference
on Field Cycling NMR Relaxometry**

Turin (Italy) June 4-6, 2009

Book of abstracts

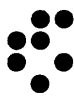
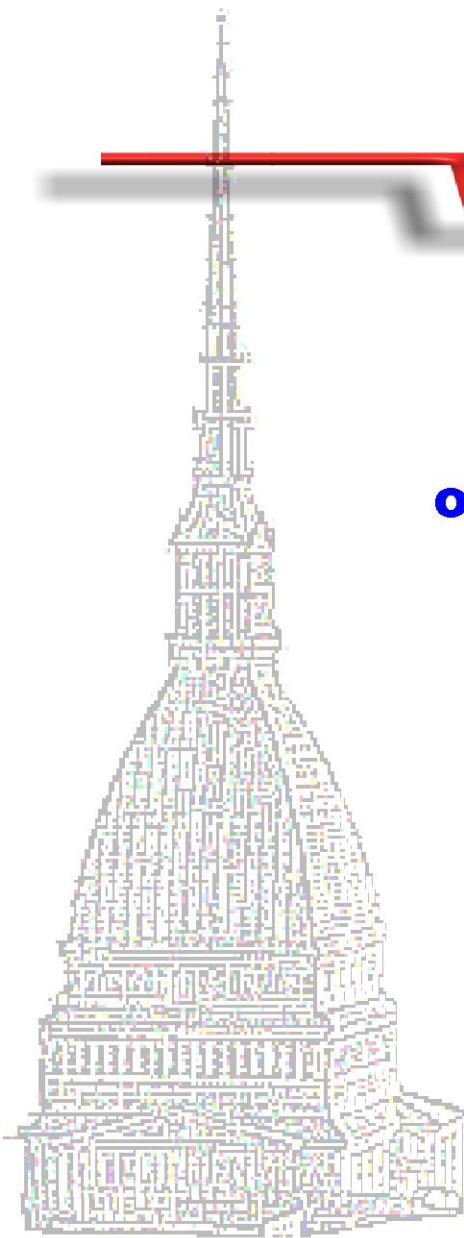

The **First symposium on Field Cycling NMR Relaxometry** was held in Berlin 1998, with the purpose of:

- bringing together all the researchers practicing FC methods with those who do not yet but are interested in applying this technique in the future
- forming a discussion forum promoting and cultivating the description of molecular motions in complex system by spectral densities in relation to recent condensed matter theories and
- dissemination of the information on the technique as well as the potential of its applications and it proved to be a big success.

The following conferences, held in Torino in 2001, 2003, 2005 and 2007 were aimed with the intention of strengthening the interaction between FC users of different areas, stimulating the exchange of new ideas and technical features.

Following the success of the previous meetings, the 6th symposium wants to congregate again the fast growing and enthusiastic community of FC users & developers

As in the past the aim of this 6th workshop is :

- to gather people with active interests in nuclear and electron spin relaxation, fast magnetic field switching experiments, low field magnetic resonance, nuclear electric quadrupole resonance, and magnetic imaging.
- to focus discussion on magnetic field cycling experimental techniques, data interpretation and theory, as well as applications performed by other low-frequency and low resolution NMR techniques to span a range of topics including experimental issues, interpretative foundations, liquids, solids, porous and heterogeneous materials, polymers, biological materials, and diagnostics.

This year is particularly special in keeping with these objectives. The 6th Conference of Field Cycling follows another very important NMR Field Cycling event: the First **Summer School On Field Cycling NMR Relaxometry** which is held in Mede (PV) -Italy on June 1-3, 2009 for the first time.



The NMR School of Mede wants to be a comprehensive introduction to the NMR Field Cycling and NMR Relaxometry on the aim to enable researchers of any scientific discipline to profit in their work from the exceptional capacity of the field-cycling technology. A number of top-leading scientists contribute to the program on FC technique and interdisciplinary applications, models, methods, applications and instrumentations. <http://www.ffcrelax.com/schoolNMR/home.php>

Scientific Committee:

- Silvio Aime
- Gianni Ferrante
- Rainer Kimmich
- Robert G. Bryant
- David Lurie
- Jean Pierre Korb
- Marija Vilfan
- Anoardo Esteban

Organizing Secretariat :

- Silla Sai Stelar s.r.l. sai@stelar.it
Via Fermi, 4 2035 Mede (PV)
- C. Spoldi and E.Lombardini Fondazione per le Biotecnogie
Via Settimio Severo, 63
10133 - Torino - ITALY

Language:

The official language of the Symposium will be English

<http://www.ffcrelax.com>

Main sponsors:

The Organizing Committee of the Symposium would like to thank the following sponsor whose financial support is gratefully acknowledged:



Stelar marks 25th Anniversary Of Company's Founding

Company Thanks Customers, Employees and friends for
Their Contributions Over Last 25 Years



Turin (Italy) - June 4-6, 2009

<http://www.ffcrelax.com>

Program

Thursday June 4, 2009

12.00-14.00 Registration

14.00-14.15 Welcome to the participants

Chair: R. Kimmich

Oral Presentation_Session I

14.15 -14.45	J.P. Korb - Ecole Polytechnique, Palaiseau, France Intermolecular dipolar relaxation and diffusive exploration of liquids at surfaces	01
14.45 -15.15	P. Levitz - Ecole Polytechnique, Palaiseau, France Probing residence time of a fluid molecule at a colloidal interface	02
15.15 -15.45	D. Petit - Ecole Polytechnique, Palaiseau, France Dynamics of ionic liquids confined in silica matrix for lithium batteries	03
15.45 -16.15	E. Anordo - Universidad Nacional de Cordoba, Argentina Interpretation of molecular dynamics on different timescales in unilamellar vesicles using field-cycling NMR relaxometry	04
16.15 -16.45	<i>coffee break</i>	

Chair: R. G. Bryant

Oral Presentation_Session II

16.45-17.15	M. Carravetta - University of Southampton, UK Singlet state NMR experiments on nitrous oxide	05
17.15-17.45	F. Reineri – University of Torino, Italy Effect of the static magnetic field strength on PHIP (ParaHydrogen Induced Polarization) NMR spectra	06
17.45-18.15	H.M. Vieth - Free University of Berlin, Germany T_1 relaxation dispersion of scalar coupled multi-spin systems	07
18.15-18.45	K. L. Ivanov - International Tomography Center, Russia Para-Hydrogen Induced Polarization in multi-spin systems studied at variable magnetic field	08
18.45-21.30	<i>Poster Session and Welcome Party</i>	

Friday, June 5, 2009

Chair: R. N. Muller		Oral Presentation_Session III
8,30-9,00	R.G. Bryant – University of Virginia, Charlottesville, USA Contributions to water ^1H relaxation induced by protein-bound paramagnets in solution	09
9,00-9,30	D. Lurie - University of Aberdeen – U.K Fast Field-Cycling Magnetic Resonance Imaging	010
9,30-10,00	B. Rutt – Stanford University, USA Delta Relaxation Enhanced Magnetic Resonance Imaging	011
10,00-10,30	L. Helm - EPFL Lausanne, Switzerland Relaxometry of homoleptic acetonitrile complexes of lanthanide ions	012
10,30-11,00	Coffee break	
Chair: L. Helm		Oral Presentation_Session IV
11,00-11,30	P. H. Fries - CEA-Grenoble, France Outer-sphere intelligence service to decipher the relaxivity of a Gd^{3+} -based contrast agent	013
11,30-12,00	D. Brougham – Dublin City University, Ireland Field-cycling relaxometry in the development of magnetic nanoparticle suspensions	014
12,00-12,30	M. Mariani – University of Pavia, Italy NMR investigation of novel contrast agents for MRI based on Mn-ferrites and Co-ferrites	015
12,30- 14,00	Lunch	
Chair: J.P. Korb		Oral Presentation_Session V
14,00-14,30	L. Vander Elst – University of Mons, Belgium Proton relaxometric study of Gd-C4-thyroxin-DTPA, a potential new MRI contrast agent	016
14,30-15,00	B. Halle - Lund University, Sweden Mechanism of ^1H - ^{14}N cross-relaxation in proteins	017
15,00-15,30	T. Apih – J. Stefan Institute, Ljubljana, Slovenia Field-cycled ^{14}N Nuclear Quadrupole Resonance for remote detection and pharmaceutical industry	018
15,30-16,00	J. Seliger - J. Stefan Institute, Ljubljana, Slovenia Field-cycling double-resonance measurement of ^{14}N NQR frequencies using solid effect	019
16,00-16,30	Coffee Break	
Chair: D.Lurie		Oral Presentation_Session VI
16,30-17,00	W. Medycki – Institute of Molecular Physics, Poznan, Poland Proton relaxation processes in imidazole compounds: effects of large quadrupolar coupling of bromine nuclei	020
17,00-17,30	M. Hürlimann - Schlumberger, Cambridge, USA ^1H relaxation in complex fluids characterized by one- and two-dimensional distribution functions: Application to crude oil and asphaltene aggregation	021
17,30-18,00	P. Conte – Palermo University, Italy Tridimensional molecular assembly of the major components of extra-virgin olive oils	022
18,30-20,00	- Visit to " Il Borgo Medioevale " - Torino	
20,30-11,00	- Conference Dinner at Restaurant "Idrovolante" - Parco del Valentino, Torino http://www.ristoranteidrovolante.com	

Saturday, June 6, 2009

Chair: B. Halle		Oral Presentation_Session VII
8,30-9,00	D. Kruk - Jagellonian University, Krakov, Poland Recent progress in theory of field dependent relaxation and polarization transfer processes in multi-spin systems	023
9,00-9,30	S. Sykora – Extra Byte, Italy Nuclear magnetization evolution in time-variable magnetic fields: theory and exploitation	024
9,30-10,00	M. McMahon - Kennedy Krieger Institute, Baltimore, USA Investigation of field dependency of contrast for DIACEST peptides	025
10,00-10,30	N. Fatkullin - Kazan State University, Russia Spin-lattice relaxation dispersion in polymers: Dipolar-interaction components and short- and long-time limits	026
10,30-11,00	Coffee break	
Chair: H.M. Vieth		Oral Presentation_Session VIII
11,00-11,30	E. A. Rossler – University of Bayreuth, Germany Universal polymer dynamics as revealed by fast field cycling NMR	027
11,30-12,00	S. Ayalur-Karunakaran - ITMC RWTH , Aachen, Germany Crossover from 3D to 2D melt in thin films by FFC- NMR	028
12,00-12,30	V. Domenici - Università di Pisa, Italy Dynamics of a liquid crystalline dendrimer by means of ² H NMR relaxation	029
12,30- 14,00	Lunch	
Chair: B. Rutt		Oral Presentation_Session IX
14, 00-14.30	P. J. Sebastião - Centro de Fisica de Materia Condensada, Lisbon, Portugal NMR relaxation study of molecular dynamics of liquid crystalline side-on organosiloxane tetrapodes	030
14,30-15,00	C. Mattea - TU Ilmenau, Germany Molecular Dynamics of Ionic Liquids Studied by NMR relaxometry	031
15,00-15,30	A. V. Yurkovskaya - Free University of Berlin, Germany Low field time-resolved Dynamic Nuclear Polarization with field cycling and high resolution NMR detection	032
15,30-16,00	A. J. Horsewill - University of Nottingham, UK Tunnelling magnetic resonances: DNP and the diffusion of methyl group tunnelling energy studied by field cycling NMR	033
16,00-16,30	Coffee break	
Chair: S. Aime		Oral Presentation_Session X
16,30-17,00	L.J. Zielinski - Schlumberger, Cambridge, USA Dispersion of T ₁ magnetic relaxation distributions in crude oils	034
17,00-17,30	Bouget-Bonnet – Nancy University, France Behavior of monovalent metal cations inside a calixarene cavity as probed by nuclear spin relaxation. Evidence of cation- π interactions in water	035
17,30-18,00	H. Gustafsson - Center for Medical Image Science and Visualization (CMIV), Sweden Electron paramagnetic resonance of Gd ₂ O ₃ - nanoparticles	036
18,00	Conclusion and remarks	

Oral Presentations

Intermolecular dipolar relaxation and diffusive exploration of liquids at surfaces

J.-P. Korb¹, R. G. Bryant², Y. A. Goddard², D. Grebenkov¹, B. Nicot³ and P. Ligneul³

¹Physique de la Matière Condensée, Ecole Polytechnique, CNRS, 91128 Palaiseau, France

²Chemistry Department, University of Virginia, Charlottesville, VA, USA 22904

³Schlumberger Dhahran Carbonate Research Center, P.O. Box 2836, Al-Khobar 31952, Saudi Arabia

The question of how to obtain dynamical information on liquids at solid surfaces is central to understanding transport properties in high surface-area porous materials such as cements, plasters, rocks as well as biological interfaces. However, experimental characterization of dynamics in the liquid-solid interfacial region has been challenging because it extends only nanometers from the surface. It is difficult to characterize both the local translational correlation time and the dimensionality of the exploration. Neutron scattering, magnetic relaxation spectroscopy, optical relaxation spectroscopy, and molecular dynamics simulation have partially addressed this region. Nuclear magnetic relaxation dispersion (NMRD) is uniquely suited to this problem because it provides both the dimensionality of the diffusive exploration and the translational correlation time. We present two NMRD applications to high surface area systems of various geometries and extend the studies to a protein system. In all cases, we present theoretical models of intermolecular dipolar relaxation processes induced by diffusive exploration of liquids at solid surface that permits extraction of useful dynamical parameters from the NMRD data.

The first application concerns the low-frequency dispersion of the proton NMRD of aprotic (oil) and protic (water) diphasic liquids in multimodal porous rocks that provide their relative wettabilities. We predict theoretically the specific dispersion relaxation features of aprotic liquids diffusing in the proximity of paramagnetic relaxation sites at pore surfaces and protic liquids bounded to these sites. We apply this non-invasive *in situ* method to carbonate reservoir rocks of bimodal porosity and we confirm experimentally the predictions of the relaxation features for aprotic and protic liquids as well as pore-size dependence of wettability.

The second application concerns a quantitative characterization of water molecule dynamics at protein interfaces. This is critical to understanding the time and frequency dependence of the energetic costs of intermolecular events such as molecular recognition. Water dynamics also determine the effective interfacial viscosity. Here we show that the water-proton spin-lattice relaxation rate constants are logarithmic functions of the Larmor frequency and the water translational correlation time at the protein surface is 30 ps for self diffusion and 15 ps for relative diffusion of water molecules. The critical feature of the data is that the logarithmic field dependence implies that the 2-particle re-encounter probability density at the surface is strongly biased by the steric constraints of the surface and is characteristic of a 2-dimensional rather than a 3-dimensional exploration. This translational bias is a general result of the small molecule that is observed diffusing in the vicinity of a large molecule or surface that provides barrier or excluded volume.

Probing residence time of a fluid molecule at a colloidal interface

*P. Levitz, J-P Korb, D. Petit, G. Kassab**

Physique de la Matière Condensée, Ecole Polytechnique-CNRS, Palaiseau, 91128 France.

E-mail : pierre.levitz@polytechnique.edu

Self-diffusion of a molecule over a surface is characterized by a succession of adsorption steps and bulk relocations from one point to another point of the interface. Adsorption statistics such as the adsorption time distribution and its first moment reflect the degree of interaction of the diffusing particle (eventually the solvent) with the colloidal interface. The relocation statistics strongly depends on the shape of the colloidal particle and the bulk confinement [1-3].

As shown by the Kimmich's group, NMR relaxometry is a powerful tool to investigate such an intermittent Brownian dynamics. In this context, we first discuss the possibility to probe the residence time of a fluid molecule at the colloidal interface. We then present some experimental investigations using the NMR relaxometry on various colloidal systems (Plaster pastes [4], reverse micelle [5], mineral strand [3]). Comparison with analytical derivations and /or simulation is discussed. Evaluation of the fluid-surface interaction in term of "nanowettability" is emphasized.

[1] P. Levitz, J. Phys. Cond. Mat. 17, S4059 (2005)

[2] P. Levitz, D. S. Grebenkov, M. Zinsmeister, K. Kolwankar, B. Sapoval, Phys. Rev. Lett. 96, 180601 (2006).

[3] P. Levitz, M. Zinsmeister, P. Davidson, D. Constantin, and O. Poncelet. Phys. Rev. E 78, 030102 (R) (2008).

[4] J-P Korb and P Levitz Proceedings of MRPM9 , Boston (2008)

[5] G. Kassab, D. Petit, J-P Korb, T. Tajouri, and P. Levitz , C.R.A.S., 9 (3-4): 493-497 (2006)

** On leave from University of Tunis, UR 01 UR13-04, Tunisia*

Dynamics of ionic liquids confined in silica matrix for lithium batteries

D. Petit^a, J.-P. Korb^a, P. Levitz^a, J. Le Bideau^b, D. Brevet^b

^aPMC, Ecole Polytechnique-CNRS, Route de Saclay, Palaiseau, 91128 France.

^bChimie Moléculaire et Organisation des Solides, Institut Charles Gerhardt, Université Montpellier 2, 34095 Montpellier, France

E-mail : dominique.petit@polytechnique.edu

Ionic liquids are known for their high ionic conductivity and their wide electrochemical potentialities. They have recently been used as electrolytes in solar and fuel cells [1, 2] and lithium batteries [3]. For such applications, these ionic liquids have been immobilized in a solid matrix [4, 5]. However, the molecular dynamics of these liquid-like ions within a disordered solid matrix is still unknown. Here, we choose the (1-butyl-3-methylimidazolium bis(trifluoromethylsulfonyl)imide) [BMI][TFSI] as an anion-cation pair of ionic liquid confined within a silica-like mesoporous matrices made by a sol-gel route from hydrophobic methyl groups precursors (ionogels made from tetramethoxysilane, methyltrimethoxysilane ; lithium salt Li TFSI was added). In a first step, we have measured the proton nuclear magnetic relaxation dispersion (NMRD) of the confined proton-bearing cation [BMI]. The frequency dependence of $1/T_1$ behaves as a power law, $1/T_1 \sim \omega^{-1/2}$, over more than three orders of magnitude. This suggests a very slow decay of the intramolecular dipolar fluctuations of this confined cation at proximity of the pore surface. Such a power law remains over a very large range of temperature (10°C-70°C). This suggests a translational diffusion process at proximity of the pore surface. Several dynamical parameters have been determined from these proton NMRD such as: translational correlation time, activation energy as well as a surface diffusion coefficient that is similar to the one determined by quasi-elastic neutron scattering [6]. Moreover, we have observed a modification of the diffusive regime above 300K in conformity to recent conductivity measurements [5]. An estimation of the length of persistence associated to an average radius of curvature of the pores has been reached from the cross-over to a frequency independence of $1/T_1$ observed at low frequency. Last, we show the ^{19}F NMRD of the proton-free anion [TFSI] and obtained a power-law behaviour almost similar to the protons. This is in favour of a very-correlated dynamical motion of the anion-cation pair at room temperature within the solid and disordered silica matrix. Both the methods and the theories presented here can be applied more widely to other conducting porous media.

This work is supported by the Agence National de la Recherche ANR-06-NANO-003

- [1] B. O'Reagan and M. Graetzel, *Nature* 353, 737-740 (1991).
- [2] H. Nakamoto and M. Watanabe, *Chem. Commun.* 2339-2541 (2007).
- [3] M. Diaw, A. Chagnes, B. Carre, P. Wilmann and D. Lemordant, *J. Power sources* 146, 682-684 (2005).
- [4] J. Le Bideau, P. Gaveau, S. Bellayer, M.A. Néouze and A. Vioux, *Phys. Chem. Chem. Phys.* 9, 5419-5422 (2007).
- [5] M.-A. Neouze, J. Le Bideau, P. Gaveau, S. Bellayer and A. Vioux, *Chem. Mater.*, 2006, 18, 3931-3936.
- [6] S. Mitra, J.-M. Zanotti, M.-A. Néouze, S. Bellayer, A. Vioux and J. Le Bideau, *submitted*.

Interpretation of molecular dynamics on different timescales in unilamellar vesicles using field-cycling NMR relaxometry

Carla J. Meledandri,¹ Josefina Perlo,² Ezequiel Farrher,² Dermot F. Brougham¹ and Esteban Anoardo².

1. National Institute for Cellular Biotechnology, School of Chemical Sciences, Dublin City University, Dublin 9, Ireland.

2. Larte – Famaf. Universidad Nacional de Córdoba and IFFAMAF (CONICET). Córdoba – Argentina.

Both laboratory-frame and rotating-frame nuclear magnetic resonance relaxometry were used to study the molecular dynamics in unilamellar liposome systems of diameter about 100 nm composed of 1,2-dimyristoyl-*sn*-glycero-3-phosphocholine (DMPC) or 1,2-dioleoyl-*sn*-glycero-3-phosphocholine (DOPC). The spin-lattice relaxation dispersions were interpreted in terms of clearly defined relaxation mechanisms associated with the underlying molecular dynamics. The physical parameters obtained from the analysis are consistent with values available in the literature obtained from a range of experimental techniques. We conclude that the methodology here employed can therefore be validly applied to the study of liposomes of more complex formulation, to investigate the effect of composition on the important physicochemical properties of these model carrier systems.

Singlet state NMR experiments on nitrous oxide

Marina Carravetta, Giuseppe Pileio and Malcolm H. Levitt

School of Chemistry, Southampton University, SO17 1BJ Southampton, UK

We present new applications of singlet state NMR experiments on fully ^{15}N labelled nitrous oxide. This system exhibits remarkably long relaxation times which make it a suitable candidate for a wide range of practical applications and for hyperpolarization experiments.

Experimental demonstration of a remarkably long-lived spin state for nitrous oxide is given in deuterated and non-deuterated solvents.

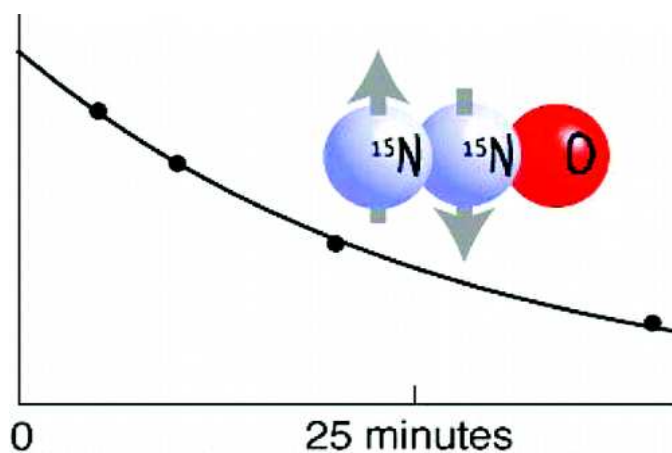

Low field NMR experiments with direct manipulation of the singlet state are also demonstrated.

Effect of the static magnetic field strength on PHIP (ParaHydrogen Induced Polarization) NMR spectra

Daniel Canet¹, Sabine Bouguet-Bonnet¹, Francesca Reineri²

¹ *Méthodologie RMN (CRM2, UMR CNRS-UHP 7036), Nancy-Université, BP 239, 54506 Vandoeuvre-lés-Nancy Cedex, France.*

² *Dipartimento di Chimica I.F.M. and Center for Molecular Imaging, Università degli Studi di Torino, Via P. Giuria 7, 10125 Torino, Italy.*

Spin polarization transfer from para-hydrogen ($p\text{-H}_2$) to another molecular entity is generally thought to be mediated by longitudinal spin order (represented by the operator product $I_z^A I_z^B$, A and B being the two hydrogen nuclei which originate from $p\text{-H}_2$ after an hydrogenation reaction). The longitudinal spin order leads to anti-phase patterns in the proton NMR spectrum. In addition to these anti-phase patterns, in-phase patterns, arising from polarization differences (represented by ($I_z^A - I_z^B$)), have been experimentally observed. A complete theory, based on a density operator treatment, has been worked out and applied to the two types of PHIP experiments: PASADENA (hydrogenation reaction inside the NMR magnet) and ALTADENA (hydrogenation reaction outside the NMR magnet). It is shown that polarization differences are always created in the case of a PASADENA experiment but that their amplitude depends critically on the ratio of the J coupling over the frequency difference between A and B . In the case of an ALTADENA experiment, if the sample is slowly transferred toward the NMR magnet, polarization differences are definitely created and their amplitude can be larger than the amplitude of the longitudinal spin order. Some test experiments demonstrate the validity of the proposed theory.

T₁ relaxation dispersion of scalar coupled multi-spin systems

K. L. Ivanov,^{a,b} A. V. Yurkovskaya,^{a,b} S. E. Korchak,^a H.-M. Vieth^a

^a *Freie Universität Berlin, Arnimallee 14, D-14195 Berlin, Germany*

^b *International Tomography Center, Institutskaya 3a, Novosibirsk, Russia*

A systematic study of longitudinal (T₁) relaxation in scalar coupled systems of spin 1/2 nuclei at arbitrary magnetic field will be presented. The consideration is addressed to field-cycling relaxometry experiments with high-resolution NMR detection, in which the field dependence of T₁-relaxation times, the nuclear magnetic relaxation dispersion (NMRD), can be studied for individual spins of the molecule. A theoretical approach is developed, which is based on the Redfield theory. Our study reveals several well-pronounced effects of spin-spin couplings on the NMRD curves. First, coupled spins having completely different high-field relaxation times \mathcal{T}_1^i tend to relax at low field with a common relaxation time. Second, the NMRD curves exhibit sharp features at the fields corresponding to the positions of nuclear spin level anti-crossings. Such effects of spin-spin couplings show up not only for individual spins but also for the T₁-relaxation of the total spin magnetization of the molecule. In addition, the relaxation of populations and that of coherences between the spin eigenstates become interrelated, hence coherent contributions to the longitudinal relaxation cannot be omitted. The coherences result in an oscillatory component in the relaxation kinetics. We established conditions, under which spin coupling affects the NMRD curves. Coupling alone is not sufficient for influencing the low-field relaxation as long as the relation $J_{ij}\mathcal{T}_1^i \ll 1$ is fulfilled.

Once the parameters $J_{ij}\mathcal{T}_1^i$, however, are much larger than unity the consideration of relaxation can be simplified and reduced to the relaxation of populations of the eigen-states of the spin system. The influence of spin-spin coupling is of importance as long as the coupling strength J is larger than the inverse T₁-relaxation times of the spins. Experimental data will demonstrate these effects as observed on various molecules with spin groups of increasing complexity.

Our site-specific study of relaxation shows that strong coupling of spins has important consequences for NMRD. Understanding and simulating the relaxation dispersion curves is a prerequisite for their use in differentiating between various field-dependent relaxation mechanisms and in analyzing intra-molecular dynamics and mobility of molecules, in particular, of biologically relevant compounds. Moreover, not only relaxation of longitudinal order is affected but that of other spin orders as well. In this context the relaxation of the long-lived states of coupled spins is of particular interest, since they may be useful for studying slow molecular dynamics or for storing hyperpolarization.

This work was supported by the EU (Bio-DNP grant # 011721) and the RFBR (project # 08-03-00539-a, 09-03-00837-a).

Para-Hydrogen Induced Polarization in Multi-spin Systems Studied at Variable Magnetic Field

K. L. Ivanov,^{a,b} S. E. Korchak,^a A. V. Yurkovskaya,^{a,b} H.-M. Vieth^a

^a *Institut für Experimentalphysik, Freie Universität Berlin, Arnimallee 14, D-14195 Berlin, Germany*

^b *International Tomography Center, Institutskaya 3a, Novosibirsk, Russia*

In the present work we have developed a theoretical description of Para-Hydrogen Induced Polarization (PHIP) in coupled multi-spin systems. We have considered a situation where PHIP is prepared at arbitrary external magnetic field B_p and have taken into account the effects of field cycling on the PHIP pattern. We have considered scalar spin-spin interactions as the leading factor governing PHIP formation and transfer. At low magnetic fields these interactions make the spins strongly coupled and result in efficient coherent re-distribution of spin polarization. The strong coupling condition for two spins implies that the difference in their Zeeman interaction with the external magnetic field is smaller than or comparable to their spin-spin interaction and thus is always fulfilled once the field is small enough. We have obtained analytical results for PHIP of simple spin systems (AB, A₂B, ABX, AA'A'') for the two limiting regimes of field-cycling, namely, for adiabatic and sudden field switching.

By using a fast field-cycling device that shuttles the whole NMR probe and thereby enables high-resolution NMR detection at high field, we have studied the PHIP pattern for a set of different fields B_p in the range of 0.1 mT – 7 T. PHIP spectra have been measured for ethylbenzene, which is the product of catalytical reaction between the para-hydrogen and styrene. Additionally, polarization of ethylbenzene, which is bound to the catalyst, and of the starting styrene molecule has been analyzed. It is for the first time that the field dependence of PHIP has been determined experimentally. The spectra obtained are in perfect agreement with the calculated ones for the CH₂ and CH₃ protons of ethylbenzene and even for its weakly polarized aromatic protons. Analysis of the styrene polarization shows pronounced effects of the time profile of the field variation on the PHIP pattern.

Our study gives strong evidence that scalar spin-spin interactions determine the PHIP pattern. Possible applications of the theory are discussed as well as the optimal conditions for formation of PHIP and its transfer to other nuclei.

Financial support by the Sixth Framework Programme of the European Community (Bio-DNP grant No. 011721), the Russian Fund for Basic Research (RFBR project No. 07-03-00424) and the Program of the Division of Chemistry and Material Science RAS (Project No. 5.1.1) is gratefully acknowledged. K.L.I. acknowledges support from the Alexander von Humboldt Foundation.

Contributions to Water ^1H Relaxation Induced By Protein-Bound Paramagnets In Solution

Robert G. Bryant¹, Galina Diakova¹, Yanina A. Goddard¹, Jean-Pierre Korb²
¹*Department of Chemistry, University of Virginia, Charlottesville, Virginia, USA*
²*Ecole Polytechnique, Palaiseau, France*

The paramagnetic contribution to $^1\text{H}_2\text{O}$ relaxation in protein solutions is usually separated into a rotationally correlated first coordination sphere part and an outer sphere part dominated by relative translational motion of the nuclear and electron spins. Both contributions may be important for total water relaxation rate constants and contrast in magnetic imaging contexts. For low molecular weight paramagnetic solutes, spin-labeled phospholipids, and spin-labeled glass surfaces, the usual relaxation equations for translational diffusion describe the magnetic field dependence of spin-lattice relaxation rates well and provide translational diffusion constants and distances of closest approach that agree with other measures. For spin-labeled solution phase proteins, the relaxation dispersion profile may be described by the translational diffusion relaxation equations, but while the diffusion constant is consistent with other measures at the interface, the distance of closest approach is unreasonably short indicating that the apparent strength of the electron-nuclear coupling is larger than described by acceptable dipolar interactions. There are two origins of this difficulty: 1) the translational dynamics of water at the protein interface are modified by the geometric constraints of an object with large radius; 2) the bound electron spin may also interact with water molecules that are bound to the protein for times longer than the rotational correlation time of the protein.

The surface may modify the effective reencounter probability for the diffusing protons encountering the electron spin. If the spin label is not on a long tether, i.e., surface bound, then the diffusive exploration of the region of the electron is effectively 2-dimensional, which increases the re-encounter probability and the relaxation rate. The relaxation equation for this case predicts a logarithmic dependence of the relaxation rate constant on the Larmor frequency with a low frequency plateau caused by loss of correlation when the diffusing proton escapes from the surface region. While this characteristic for diffusive motion of water at the protein interface has been demonstrated in diamagnetic proteins, by itself, this dimensionality change does not account for the total increase in relaxation efficiency over that predicted by 3-dimensional diffusive exploration of the paramagnetic interface.

There is no evidence that water in the vicinity of a nitroxide suffers long-lived hydrogen bonded lifetimes that would produce long rotational correlation times for the electron-proton dipolar coupling. However, for larger proteins, there are long lived coordinated water molecules and labile protons on exchangeable sites that cause the efficient coupling of the water proton relaxation to the rotational motion of the protein. This coupling produces the well known protein rotational for the water protons in the relaxation dispersion profile. In isolating the paramagnetic contributions to relaxation, the diamagnetic rotational contribution is subtracted; however, there may still be a paramagnetic contribution to relaxation from long-lived protons and water molecules that are correlated with the long T_{1e} electron by rotational reorientation. Because the rotational correlation time of the protein is generally at least a thousand times slower than the relative translational correlation time, this contribution may be efficient even if the inter-moment distance is large. Thus, a dipolar coupling between a protein bound nitroxide and a long-lived water molecule that may be 10 or more Angstroms away make a measurable contribution to the relaxation rate constant. Further, because both ω_I and ω_S terms in the spectral density may contribute, the high frequency local motions of the bound water molecules may contribute at high frequencies. The analytical difficulty is that precise knowledge of the distances and local dynamics of all bound water molecules are generally not available which makes interpretation of the relaxation rate constants quantitatively ambiguous.

Supported by the NIH, RO1 NIBIB 28005.

Fast Field-Cycling MRI

D.J. Lurie, L. Broche, C.-H. Choi, G.R. Davies, S.R. Ismail, D. O Hogain, K.J. Pine
Aberdeen Biomedical Imaging Centre, University of Aberdeen, UK
<http://www.ffc-mri.org>

The use of fast field-cycling (FFC) in magnetic resonance imaging (MRI) has so far been limited to relatively few applications, carried out in a small number of laboratories, but is gradually increasing.

The majority of work on FFC-MRI has been accomplished using dual magnet systems, where a homogeneous, stable magnet is used to read out NMR signals, while a less homogeneous magnet is used to boost (or reduce) the applied field during the evolution period. In our lab we have built a whole-body FFC-MRI system using a 59 mT permanent magnet for detection, with a coaxial resistive magnet for field offset [1]. This has the advantage of little or no eddy currents during field switching, as the ferrite permanent magnet is non-conductive. Our next-generation system used a 0.45 T superconducting magnet for readout, with an actively-shielded resistive field-offset magnet [2]. We are currently building a new FFC-MRI system that will employ a single magnet for polarisation, evolution and detection, which should afford significantly more flexibility in the design and execution of FFC-MRI pulse sequences.

Over recent years the range of applications of FFC-MRI has increased. Relaxometric imaging was first demonstrated by Carlson in 1992 [3], and since then relaxometric imaging methods have been implemented by the groups in Aberdeen [5], Stanford [6] and Ontario [7]. We have recently implemented localised, image-guided FFC relaxometry, whereby T_1 dispersion curves can be obtained from well-defined regions of a sample pre-selected from pilot images [8]. Another application of FFC-MRI being pursued in our lab is the combination of FFC-MRI with magnetisation transfer contrast (MTC) imaging [9].

This presentation will survey some of the methods and applications of FFC-MRI, in our own and other laboratories. Details of many aspects of this work from our laboratory can also be found on a number of posters at this meeting.

References:

- [1] Lurie D.J., Foster M.A., *et al.*, Phys. Med. Biol. **43**, 1877-1886 (1998).
- [2] Lurie D.J., Davies G.R., *et al.*, Magn.Reson.Imaging **23**, 175-181 (2005).
- [3] Carlson J.W., Goldhaber D.M., *et al.*, Radiology **184**, 635-639 (1992).
- [5] Lurie D.J., 1st Symposium on Field-Cycling NMR Relaxometry, Berlin, p5, July 1998.
- [6] Ungersma S.E., Matter N.I., *et al.*, Magn.Reson.Med. **55**, 1362-1371 (2006).
- [7] Alford J.K., Rutt B.K. *et al.*, Intl.Soc.Magn.Reson.Med., 17th Annual Meeting, Honolulu, USA, p811 (2009).
- [8] Pine K.J., Davies G.R. and Lurie D.J., Intl.Soc.Magn.Reson.Med., 17th Annual Meeting, Honolulu, USA, p2743 (2009).
- [9] Choi C.-H., Davies G.R. and Lurie D.J., Intl.Soc.Magn.Reson.Med., 17th Annual Meeting, Honolulu, USA, p2747 (2009).

¹Brian Rutt, ²Jamu Alford, ²Blaine Chronik
¹Stanford University, Stanford, California, USA
²University of Western Ontario, London, Ontario, Canada

Abstract

Molecular imaging is the *in-vivo* study and measurement of biological processes at the molecular level (1). Popular molecular imaging modalities include positron emission tomography, single photon emission computed tomography, magnetic resonance imaging, and optical imaging. These modalities rely upon probes or tracers to enhance sites of target molecules or tissues through the complementary processes of accumulation and activation. Accumulation occurs when the local concentration of the probe is increased through metabolic uptake or molecular adhesion and is the principle mechanism for localized image enhancement in nuclear medicine. Some newer probes are activatable, their behavior mediated by interaction with the target molecule. Activatable probes are used in both optical imaging and MRI studies to improve the specificity of the probe (2). Ideally activatable probes would produce no image enhancement in the inactivated state; however, to date, these probes combined with conventional MRI have shown image intensity enhancement in both inactivated and activated states, with relatively modest signal intensity ratios between these two states. Herein we describe a means of obtaining increased specificity in magnetic resonance (MR) molecular imaging by utilizing an auxiliary electromagnet to modify the strength of the main magnetic field as a function of time in an otherwise standard MRI scanner. Due to the unique response in relaxivity of activatable contrast agents, this technique allows one to specifically identify the location of activated contrast agents within an MR image.

Using a paramagnetic MR probe, image intensity increases at sites of MR probe accumulation as a result of the dominating effect of a decreased longitudinal relaxation time (T_1). The strength of a T_1 contrast agent is best described by its longitudinal relaxivity, r_1 ($s^{-1} mM^{-1}$); the larger the r_1 , the greater its efficiency at increasing the longitudinal relaxation rate R_1 of surrounding tissues and thereby enhancing signal in T_1 weighted MR images. The longitudinal relaxation rate of a tissue which has taken up a T_1 contrast agent of concentration $[CA]$ and relaxivity r_1 can be written as $R_1 = R_{1\text{Unenhanced}} + r_1 \cdot [CA]$. The rate of molecular tumbling of a contrast agent in tissue is a factor in determining the relaxivity, r_1 (4). Rapidly tumbling molecules exhibit lower relaxivities (typically $< 10 s^{-1} mM^{-1}$) that decline gradually with increasing magnetic field strengths above 0.5 T. Newer activatable contrast agents are designed to change size and/or to bind more specifically and strongly to certain proteins or classes of proteins or other macromolecular or cellular entities. Upon binding, the resulting decreased tumbling rate has been shown to produce a dramatic increase in r_1 at low field strengths (e.g. 0.5 T), with relatively little enhanced relaxivity at higher field strengths (e.g. above 3 T).

MS-325 is one particular example of a gadolinium chelate of similar size to conventional Gd-DTPA; however, by virtue of the addition of a lipophilic diphenylcyclohexyl group, this molecule shows strong non-covalent binding to serum albumin (5,6). In the presence of human serum albumin, the bound form of this agent demonstrates an increase of relaxivity by approximately an order of magnitude at 30 Mhz, and approximately four-fold at 60 MHz. In another instance, the agent bis-5-HT-DTPA(Gd) has been developed as a "sensor" of the enzyme myeloperoxidase (8). In the presence of active myeloperoxidase, this agent converts from a monomeric form with minimal protein binding characteristics and relaxivity similar to that of Gd-DTPA, to an oligomeric form with stronger protein binding affinity, leading to enhanced relaxivity. These two examples of gadolinium-based agents represent the promise of activatable MR contrast agents, but also illustrate a limitation of this class of agents. That is, the activation-induced relaxivity enhancement may be relatively modest, especially at clinical field strengths of 1.5 T or 3 T. As a result, it may be difficult to separate intensity enhancement due to the presence of the activated agent from intensity enhancement due to the presence of larger amounts of the non-activated agent.

We introduce here a novel method to distinguish between signal intensities produced by tissues containing activated probe from all other sources of signal intensity, which we have termed delta relaxation enhanced MR (dreMR) (10). This approach finds its roots in field-cycling relaxometry imaging methods used by Carlson *et al.* (11) as a means to differentiate biological tissues. Carlson outfitted a 64 mT whole-body MR with a pulsed

electromagnet insert in order to modulate the strength of the main magnetic field during an imaging experiment. He was able to show that at low magnetic field strengths the R_1 profiles of biological tissues contained features such as cross relaxation peaks, which could permit differentiation between healthy and pathological tissues.

While Carlson used low-field R_1 field variations to identify biological tissues, our approach utilizes the relative lack of R_1 field variation (12,13) at higher field strengths as a means to reject signal from both unenhanced tissues and tissues enhanced by inactivated probe. Defining R_1' and r_1' as the derivatives of R_1 and r_1 with respect to B_0 results in $R_1' = R_{1\text{Unenhanced}}' + r_1' * [CA]$. Applying the approximation that $R_{1\text{Unenhanced}}' \approx 0$ for fields above 1.0 T, results in the expression $R_1' \approx r_1' * [CA]$. This simple relation shows that the rate of change of the longitudinal relaxation rate (R_1') depends almost exclusively on the rate of change of probe relaxivity (r_1') with magnetic field. While activated probes demonstrate high values of r_1' , inactivated probes have r_1' values close to zero. For MS-325, the relaxivity *slope* enhancement ratio (ratio of activated r_1' to inactivated r_1') is 90 at 1.5 T. This represents a 25-fold increase over the absolute relaxivity enhancement ratio of 3.7. The high specificity of dreMR enhancement is not specific to MS-325 but would apply to any T_1 contrast agents that undergo binding to large molecules or significant change in molecular dynamics or water access to the paramagnetic center upon activation (14).

Transforming R_1' into image contrast requires the ability to dynamically vary the strength of the main magnetic field in an MR system. Access to such platforms is limited to a handful of sites worldwide (15-17); however, an alternative approach involves outfitting clinical MR systems with custom electromagnetic coils to enable variable field operation. The magnetic field shift need only be applied during longitudinal relaxation periods where extremely high stability and homogeneity are not necessary. The main field would not be altered during actual signal acquisition or any radiofrequency pulse application. This means that the normal radiofrequency transmit/receive chain can be used without modification. In this paper, we present the theory and first experimental demonstration of dreMR, using a small-bore actively-shielded field-cycling electromagnet within an otherwise conventional 1.5 T clinical MR scanner.

References

1. Weissleder R, Mahmood U. Molecular imaging. *Radiology* 2001;219(2):316-333.
2. Nahrendorf M, Sosnovik DE, Weissleder R. MR-optical imaging of cardiovascular molecular targets. *Basic research in cardiology* 2008;103(2):87-94.
3. Hendrick RE, Haacke EM. Basic physics of MR contrast agents and maximization of image contrast. *J Magn Reson Imaging* 1993;3(1):137-148.
4. Wood ML, Hardy PA. Proton relaxation enhancement. *J Magn Reson Imaging* 1993;3(1):149-156.
5. Caravan P, Cloutier NJ, Greenfield MT, McDermid SA, Dunham SU, Bulte JW, Amedio JC, Jr., Looby RJ, Supkowski RM, Horrocks WD, Jr., McMurry TJ, Lauffer RB. The interaction of MS-325 with human serum albumin and its effect on proton relaxation rates. *Journal of the American Chemical Society* 2002;124(12):3152-3162.
6. Henrotte V, Vander Elst L, Laurent S, Muller RN. Comprehensive investigation of the non-covalent binding of MRI contrast agents with human serum albumin. *J Biol Inorg Chem* 2007;12(6):929-937.
7. Eldredge HB, Spiller M, Chasse JM, Greenwood MT, Caravan P. Species dependence on plasma protein binding and relaxivity of the gadolinium-based MRI contrast agent MS-325. *Investigative radiology* 2006;41(3):229-243.
8. Nahrendorf M, Sosnovik D, Chen JW, Panizzi P, Figueiredo JL, Aikawa E, Libby P, Swirski FK, Weissleder R. Activatable magnetic resonance imaging agent reports myeloperoxidase activity in healing infarcts and noninvasively detects the antiinflammatory effects of atorvastatin on ischemia-reperfusion injury. *Circulation* 2008;117(9):1153-1160.
9. Overoye-Chan K, Koerner S, Looby RJ, Kolodziej AF, Zech SG, Deng Q, Chasse JM, McMurry TJ, Caravan P. EP-2104R: a fibrin-specific gadolinium-Based MRI contrast agent for detection of thrombus. *Journal of the American Chemical Society* 2008;130(18):6025-6039.
10. Alford JK. Delta relaxation enhanced MR (DREMR): Theory of T1-slope weighted contrast. ISMRM. Toronto, Canada; 2008.
11. Carlson JW, Goldhaber DM, Brito A, Kaufman L. MR relaxometry imaging. Work in progress. *Radiology* 1992;184(3):635-639.
12. Bottomley PA, Foster TH, Argersinger RE, Pfeifer LM. A review of normal tissue hydrogen NMR relaxation times and relaxation mechanisms from 1-100 MHz: dependence on tissue type, NMR frequency, temperature, species, excision, and age. *Med Phys* 1984;11(4):425-448.
13. Henriksen O, de Certaines JD, Spisni A, Cortsen M, Muller RN, Ring PB. In vivo field dependence of proton relaxation times in human brain, liver and skeletal muscle: a multicenter study. *Magn Reson Imaging* 1993;11(6):851-856.
14. Zhou X, Caravan P, Clarkson RB, Westlund PO. On the philosophy of optimizing contrast agents. An analysis of ^1H NMRD profiles and ESR lineshapes of the Gd(III) complex MS-325+HSA. *J Magn Reson* 2004;167(1):147-160.
15. Gilbert KM, Handler WB, Scholl TJ, Odegaard JW, Chronik BA. Design of field-cycled magnetic resonance systems for small animal imaging. *Phys Med Biol* 2006;51(11):2825-2841.
16. Matter NI, Scott GC, Grafendorfer T, Macovski A, Conolly SM. Rapid polarizing field cycling in magnetic resonance imaging. *IEEE Trans Med Imaging* 2006;25(1):84-93.
17. Lurie DJ, Foster MA, Yeung D, Hutchison JM. Design, construction and use of a large-sample field-cycled PEDRI imager. *Phys Med Biol* 1998;43(7):1877-1886.

Relaxometry of homoleptic acetonitrile complexes of lanthanide ions

Gabriela Bodizs, Lothar Helm

Institut des Science et Ingénierie Chimiques, EPFL, Lausanne, Switzerland

Lanthanide compounds are Lewis acids and have found applications as catalysts in organic synthesis. However, in contrast to aqueous solutions, non-aqueous polar solvents such as dimethylformamide (DMF), dimethylsulfoxide (DMSO) and acetonitrile, in which Ln^{3+} salts are soluble, have attracted only little attention. Acetonitrile is one of the preferred solvents for catalytic reactions with lanthanides because it forms very weak and labile complexes with these ions. The precursor of any metal complex in aqueous or non-aqueous solution is the solvated metal ion and therefore knowledge about the number and the lability of solvent molecules in the first coordination sphere of these cations is fundamental to an understanding of ligand substitution processes.

Total halide abstraction from LnCl_3 by $\text{Ag}[\text{Al}(\text{OC}(\text{CF}_3)_3)_4]/\text{CH}_3\text{CN}$ has been confirmed for a series of lanthanide metal ions by the structural characterization of $[\text{Ln}(\text{CH}_3\text{CN})_n][\text{Al}(\text{OC}(\text{CF}_3)_3)_4]_3$ ($n = 9$, $\text{Ln}^{3+} = \text{Nd}, \text{Eu}, \text{Gd}, \text{Dy}$; $n = 8$, $\text{Ln}^{3+} = \text{Tm}$) complexes. Evidence for the very low coordinating ability of the $[\text{Al}(\text{OC}(\text{CF}_3)_3)_4]^-$ anion towards Ln^{3+} ions is provided in the solid state (X-ray, IR and Raman spectroscopy) and in anhydrous acetonitrile solution (conductivity, EPR and NMR measurements).

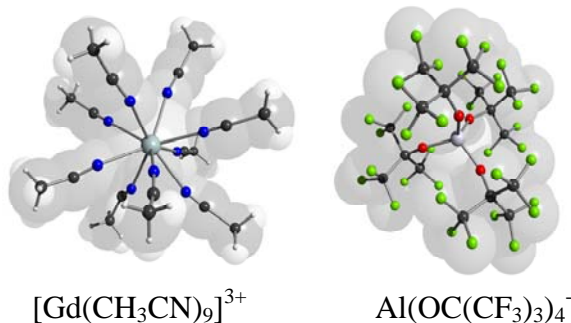

The rate constants of the acetonitrile exchange reaction as well as the rotational dynamics of the homoleptic acetonitrile Nd^{3+} , Gd^{3+} , Dy^{3+} , Tm^{3+} and Eu^{2+} complexes have been achieved by variable temperature and multiple field ^{14}N NMR, ^1H NMRD or EPR measurements. It has been observed that the overall labilities of the CH_3CN ligands are the highest ones measured so far in non-aqueous solvents on lanthanides.

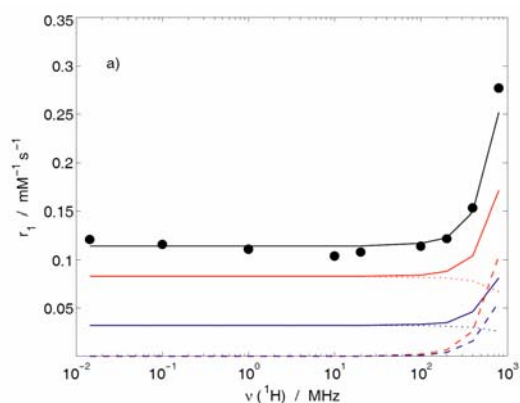

^1H NMRD profile of $[\text{Dy}(\text{CH}_3\text{CN})_9]^{3+}$ in CH_3CN at 298 K.

For the complexes of Nd, Dy and Tm, ^1H NMRD profiles of acetonitrile protons have been investigated between 0.01 and 800 MHz. The shapes of the NMRD profiles are quite similar to those observed for the corresponding lanthanide aqua ions. In the present case, the experimental profiles have been interpreted as due to inner- and outer-sphere contributions of both proton-electron dipolar coupling and Curie relaxation mechanisms. A combined analysis of the ^1H NMRD data with the ^{14}N NMR longitudinal relaxation rates allowed a more accurate determination of the rotational correlation time of the acetonitrile complexes.

Outer-sphere intelligence service to decipher the relaxivity of a Gd^{3+} -based contrast agent

P. H. Fries,⁽¹⁾ C. S. Bonnet,⁽¹⁾ S. Crouzy,⁽²⁾ P. Delangle⁽¹⁾

⁽¹⁾ CEA, INAC, SCIB (UMR-E 3 CEA-UJF, FRE 3200 CNRS),
Laboratoire de Reconnaissance Ionique et Chimie de Coordination,
38054, Grenoble, France

⁽²⁾ CEA, iRTSV, Laboratoire Chimie et Biologie des Métaux (UMR 5249 CEA CNRS UJF),
38054, Grenoble, France

Probe solutes, which carry a single set of equivalent protons and do not bind to the Gd^{3+} complex GdL, are considered. The experimental dipolar time correlation function (TCF) of the purely outer-sphere dynamics of such a probe solute with respect to GdL is derived from high-field NMR relaxometry in heavy water. Knowledge of this TCF enables us to characterize the fluctuating zero-field splitting Hamiltonian causing the Gd^{3+} electronic spin relaxation responsible for the low- and medium field relaxivity quenching. It also yields the outer-sphere contribution to the relaxivity of the HOD protons by suitable scaling of the outer-sphere dynamics of HOD from its counterpart involving the probe solute. Using this information, the whole relaxivity profile of the water protons up to 800 MHz can be rationally interpreted in terms of the outer-, inner-, and second-sphere mechanisms, provided that the hydration number of the complex is obtained independently, e.g., from the difference of the luminescence lifetimes of Tb^{3+} in the TbL complex dissolved in light and heavy water. The whole procedure is illustrated in the case of a complex of Gd^{3+} with a prepared cyclodecapeptide bearing four side chains with carboxyl groups suitable to complex the lanthanide Ln^{3+} ions.

Field-cycling relaxometry in the development of magnetic nanoparticle suspensions

Dermot Brougham

School of Chemical Sciences, Dublin City University,
Glasnevin, Dublin 9, Ireland

Relaxation rate measurements in the clinical MRI range are often used to evaluate the magnetic resonance relaxation enhancement, or relaxivity, of potential contrast media. Over the last few years we have tried to establish field-cycling relaxometry, in the 10^3 - 10^8 Hz range, as a robust technique for the study of aqueous and non-aqueous magnetic colloids. This is a possibility because of the work of Robert Muller and his colleagues at Mons-Hainault.¹ Their theory has allowed us to apply relaxometry in developing approaches to controlling; (i) the magnetic properties of iron-oxide nanoparticles; (ii) inter-particle interactions in magnetic nano-composite suspensions; and (iii) the size of suspended magnetic nanoparticle clusters. These properties are important for downstream biomedical applications of the suspensions as they strongly influence the relaxivity, bio-distribution and potential for aggregation. In this talk I will describe some recent experiments where we have applied relaxometry to characterise magnetic nanoparticle suspensions stabilised by a range of surface active agents including; fatty acids;² lipids; polyelectrolytes;³⁻⁵ and other nanoparticles.⁶

1. "Theory of proton relaxation induced by superparamagnetic particles" A. Roch, R. N. Muller, P. Gillis *J. Chem. Phys.* 1999, *110*, 5403-5411.
2. "Non-aqueous magnetic nanoparticle suspensions with controlled particle size and nuclear magnetic resonance properties" C. J. Meledandri, J. K. Stolarczyk, S. Ghosh, D. F. Brougham *Langmuir* 2008, *24*, 14159-14165.
3. "Magnetic nanoparticle assemblies on denatured DNA show unusual magnetic relaxivity and potential applications for MRI" S. J. Byrne, S. A. Corr, Y. K. Gun'ko, J. M. Kelly, D. F. Brougham, S. Ghosh *Chem. Comm.* 2004, *22*, 2560-2561
4. "Linear assemblies of magnetic nanoparticles as MRI contrast agents" S. A. Corr, S. J. Byrne, R. Tekoriute, C. J. Meledandri, D. F. Brougham, M. Lynch, C. Kerskens, L. O' Dwyer and Y. K. Gun'ko *J. Am. Chem. Soc.* **2008**, *130*, 4214-4215.
5. Poly(sodium-4-styrene)sulfonate-iron oxide nanocomposite dispersions with controlled magnetic resonance properties" S. A. Corr, Y. K. Gun'ko, R. Tekoriute, C. J. Meledandri, D. F. Brougham *J. Phys. Chem. C* **2008**, *112*, 13324-13327.
6. "Controlled growth of nanoparticle clusters through competitive stabilizer desorption" J. K. Stolarczyk, S. Ghosh, D. F. Brougham *Angew. Chem. Int. Ed.* **2009**, *48*, 175-178.

NMR investigation of novel contrast agents for MRI based on Mn-ferrites and Co-ferrites

M. Mariani¹, T.Kalaivani^{2,3}, M. Marinone^{2,3}, A. Lascialfari^{2,3}, M. F. Casula⁴, M. Corti¹, F. Orsini², G. Poletti², A. Boni⁵, C. Innocenti⁵, C. Sangregorio⁵

¹Department of Physics "A.Volta", University of Pavia, CNISM and CNR-INFM, Via Bassi 6, I-27100 Pavia (Italy)

²Institute of General Physiology and Biological Chemistry "G. Esposito", University of Milano, I-20134 Milano (Italy) and CNR-INFM c/o Department of Physics "A.Volta", University of Pavia, I-27100 Pavia (Italy)

³S3-CNR-INFM, I-41100 Modena (Italy)

⁴Department of Chemistry and INSTM, University of Cagliari, I-09042 Cagliari (Italy)

⁵Department of Chemistry and INSTM, University of Firenze, Via della Lastruccia 3, I-50019 Sesto Fiorentino (Italy)

The Nuclear Magnetic Resonance Dispersion (NMR-D) profiles of different classes of possible novel contrast agents (CA) for Magnetic Resonance Imaging (MRI) is presented. The samples consist in Mn-ferrites and Co-ferrites compounds made up of nanoparticles (NP) with different magnetic cores ($Mn_{3-x}Fe_xO_4$ and $Co_{3-x}Fe_xO_4$ respectively). These compounds were obtained by rapid decomposition of metalcarbonyl into a hot solvent and a coordinating surfactant, followed by an oxidation step. In this way we obtained, by controlling the metal/surfactant molar ratio, various samples with different sizes of the monodisperse capped nanoparticles. We performed several characterization measurements, the first ones headed to a structural and a morphological investigation by XRD and TEM techniques. Zero-field-cooled and field-cooled SQUID magnetization measurements revealed for all the samples a superparamagnetic behaviour with blocking temperatures in the range 30-150K. The study of NMR-dispersion profiles revealed r_1 and r_2 relaxivities (i.e. the efficiency in contrasting MR images), for most of our samples, comparable to commercial compounds for frequencies $\nu > 100$ MHz, resulting in a high efficiency for high-field clinical and research Imagers. Furthermore, the Co-ferrites at low and intermediate frequencies revealed relaxivities higher than commercial SP compounds. The comparison of the relaxivities of the two series of samples allowed to highlight the crucial role of the magnetic anisotropy and of the kind of magnetic ion for the nuclear relaxation mechanism.

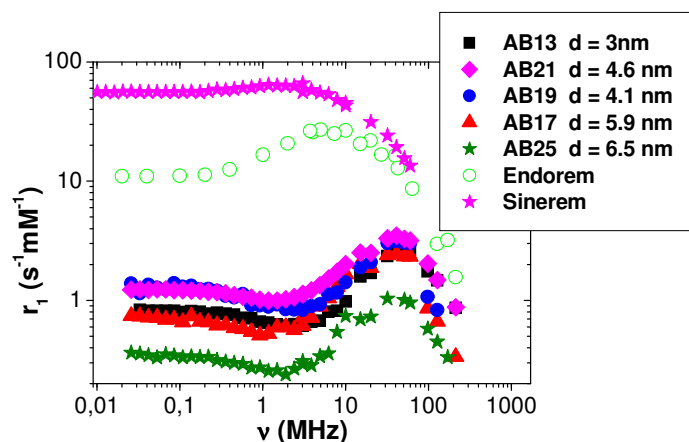

MRI TEST

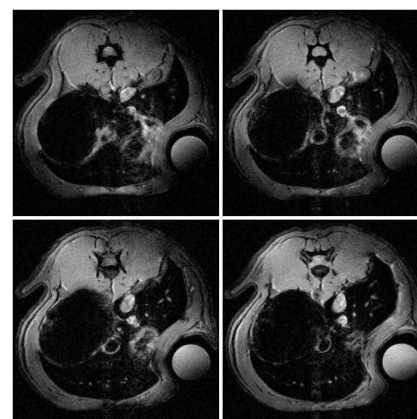

Proton relaxometric study of Gd-C₄-thyroxin-DTPA, a potential new MRI contrast agent

Henoumont C., Vander Elst L., Laurent S., Muller R.N.

Department of General, Organic and Biomedical Chemistry, Laboratory of NMR and Molecular Imaging, University of Mons.

At present, gadolinium complexes represent the main category of contrast agents which are clinically used for Magnetic Resonance Imaging (MRI). Many efforts are made in order to increase their efficacy i.e. their relaxivities, which represent the increase of the water proton relaxation rate induced by 1 mmol per liter of the gadolinium chelates. To reach this objective, complexes having a high affinity for an endogenous macromolecule are well appropriate since the increase of the molecular size of the gadolinium complex due to its non covalent interaction with the macromolecule increases its relaxivity in the range of magnetic fields used in clinical MRI (0.5-1.5 T).

This work reports the characterization by proton relaxometry of a potential new MRI contrast agent, the Gd-C₄-thyroxin-DTPA, which is assumed to have a relatively high affinity for human serum albumin (HSA). Firstly, its NMRD profile was recorded in water on solutions of increasing concentration of the Gd-complex. The obtained curves show a hump at high field, between 0.5 and 1.5 T, which increases as the concentration of the chelate increases. This can be explained by an aggregation of the molecules in solution at concentrations larger than 0.6 mM. Secondly, the NMRD profile of Gd-C₄-thyroxin-DTPA was recorded in the presence of HSA 4%. The large increase of relaxation rate observed at high field shows that this chelate has a high affinity for HSA. The relaxivity of the bound complex at 20 MHz and 310K was estimated to be of the order of 45-50 s⁻¹mM⁻¹. Finally, competition experiments were performed with ibuprofen and salicylate, of which the binding sites on HSA are known. The NMRD profiles of Gd-C₄-thyroxin-DTPA were recorded in the presence of HSA 4% and of different concentrations of the competitors. The results show a more important decrease of the water proton relaxation rate at all magnetic fields in the presence of ibuprofen which means that Gd-C₄-thyroxin-DTPA shares one of the binding sites of ibuprofen on HSA.

MECHANISM OF ^1H - ^{14}N CROSS-RELAXATION IN PROTEINS

Erik Persson and Bertil Halle

Dept of Biophysical Chemistry, Lund University, SE-22100 Lund, Sweden

It has been known for some time that ^{14}N spins in peptide groups can act as relaxation sinks for the water- ^1H magnetization in aqueous samples containing rotationally immobilized proteins.¹ This cross-relaxation phenomenon occurs at magnetic field strengths where the ^1H Larmor frequency matches one of the three eigenfrequencies of the ^{14}N (Zeeman + quadrupolar) spin Hamiltonian, giving rise to characteristic peaks in the ^1H MRD profile in the range 0.5 – 3 MHz. Such quadrupolar peaks have been observed for proteins immobilized by physical crowding,¹⁻⁵ by chemical cross-linking,⁶ or by specific interactions in excised tissue^{4,5} and in living organisms.^{2,4,7}

The quadrupolar peak phenomenon is thought to involve three steps:

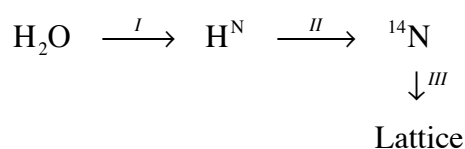

However, a quantitative model that can account for all observations is lacking. In fact, none of the three steps is understood in detail.

In this contribution, we discuss the mechanism of the quadrupolar peaks in the light of new data on cross-linked proteins under various conditions. In particular, we address the following two questions:

- Which ^1H species and what motions are involved in step I?
- Is step II a coherent polarization transfer⁸ ("resonant spin diffusion") or an incoherent cross-relaxation process (within¹ or outside⁹ the motional-narrowing regime)?

¹ F. Winter & R. Kimmich, *Molec Phys* **45**, 33 (1982).

² F. Winter & R. Kimmich, *Biochim Biophys Acta* **719**, 292 (1982).

³ F. Winter & R. Kimmich, *Biophys J* **48**, 331 (1985).

⁴ R. Kimmich, F. Winter, W. Nusser & K-H. Spohn, *J Magn Reson* **68**, 263 (1986).

⁵ S. H. Koenig, *Biophys J* **53**, 91 (1988).

⁶ X. Jiao & R. G. Bryant, *Magn Reson Med* **35**, 159 (1996).

⁷ E. Persson & B. Halle, *Proc Natl Acad Sci USA* **105**, 6266 (2008).

⁸ H. T. Stokes & D. C. Ailion, *J Chem Phys* **70**, 3572 (1979).

⁹ P-O. Westlund & H. Wennerström, *J Magn Reson* **63**, 280 (1985).

Field-cycled ^{14}N Nuclear Quadrupole Resonance for Remote Detection and Pharmaceutical Industry

T. Apih, A. Gregorovič, A. Gradišek, R. Blinc, and J. Seliger

J. Stefan Institute, Jamova 39, Ljubljana, Slovenia, e-mail: tomaz.apih@ijs.si

J. Lužnik, J. Pirnat, and Z. Trontelj

Institute for Mathematics, Physics and Mechanics, Ljubljana, Slovenia

Nuclear Quadrupole Resonance (NQR) is potentially very powerful method for remote and non-invasive detection and identification of solid substances containing quadrupole nuclei. In last two decades, there is special effort to develop ^{14}N NQR to detect nitrogen bearing explosives^[1] such as TNT or RDX. In addition, the sensitivity of ^{14}N NQR frequencies on the crystalline structure has proven to be very useful for distinguishing polymorphic structures in pharmaceutically interesting compounds. In this contribution, we present the recent results of using field-cycling enhanced NQR both for the detection of illicit substances and as a tool for the pharmaceutical industry.

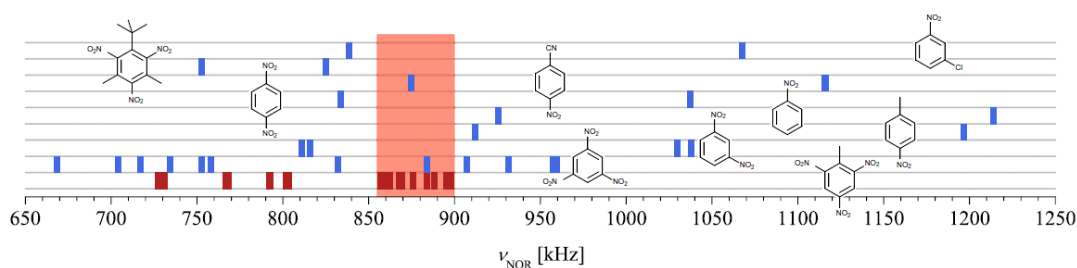

Fig.1. The sensitivity of ^{14}N NQR on the chemical and structural environment is demonstrated by the NQR frequencies of $-\text{NO}_2$ groups in some of TNT related compounds. The rows from top to bottom contain spectra for: m-chloronitrobenzene, 2,4,6-trinitro-1-t-butyl-3,5-dimethylbenzene, p-nitrobenzonitrile, nitrobenzene, p-nitrotoluene, m-dinitrobenzene, trinitrobenzene, and trinitrotoluene (orthorhombic and monoclinic). Only the ν_+ and ν_- frequencies are shown. The shaded region shows the part of the spectrum that overlaps with the TNT ν_+ frequencies.

Field-cycling double-resonance measurement of ^{14}N NQR frequencies using solid effect

Janez Seliger^{1,2} and Veselko Žagar¹

¹ »Jozef Stefan« Institute, Jamova 39, 1000 Ljubljana, Slovenia

² University of Ljubljana, Faculty of Mathematics and Physics, Jadranska 19, 1000 Ljubljana, Slovenia

Measurements of the ^{14}N nuclear quadrupole interactions are of particular importance in the study of molecular structure, crystal structure and chemical bonds in a number of organic solids. These measurements can be done by high-field NMR only in single crystals, while in powder samples the sensitivity of NMR is rather low. There is namely no central line in the ^{14}N NMR spectrum, which is only slightly shifted from the Larmor frequency. The NMR lines in powder samples are typically several MHz broad and in addition the ^{14}N magnetic moment is low.

As an alternative we use either pulsed NQR or ^1H - ^{14}N nuclear quadrupole double resonance. The double resonance techniques are based on magnetic field cycling between a high magnetic field where the proton spin system polarizes and a low magnetic field where protons and ^{14}N interact.

The choice of the double resonance technique depends on the experimental conditions. The techniques mainly used are the ^1H - ^{14}N cross relaxation spectroscopy [1, 2], the level crossing technique [3], the technique based on multiple frequency sweeps and two-frequency irradiation [5, 6] and the technique using solid effect [7].

Here we present in details the technique using solid effect. The technique is based on the simultaneous (solid effect) transitions in the ^1H and ^{14}N spin systems at the frequencies $\nu = \nu_Q \pm \nu_H$, where ν_Q is a ^{14}N NQR frequency and ν_H is the proton Larmor frequency. The transition probabilities per unit time of the solid effect transitions are calculated and the sensitivity of the double resonance technique is estimated. The double resonance spectra are calculated in the limiting cases of fast and slow nitrogen spin-lattice relaxation. Some typical double resonance spectra as measured by the solid effect technique are presented and analyzed.

References:

1. J. Seliger, R. Blinc, H. Arend and R. Kind, *Z. Phys.* **B25**, 189 (1976)
2. D. Stephenson and J. A. S. Smith, *Proc Roy. Soc. A* **416**, 149 (1988)
3. R. Blinc, M. Mali, R. Osredkar, A. Prelesnik, J. Seliger, I. Zupancic and L. Ehrenberg, *J. Chem. Phys.* **57**, 5087 (1972)
4. D.T. Edmonds, *Phys. Rep.* **29**, 234 (1977)
5. J. Seliger, V. Žagar and R. Blinc, *J. Magn. Reson. A* **106**, 214 (1994)
6. J. Seliger, V. Žagar and R. Blinc, *Z. Naturforsch.* **49a**, 31 (1994)
7. J. Seliger and V. Žagar, *J. Magn. Reson.* **193**, 54 (2008)

Proton relaxation processes in imidazole compounds: effects of large quadrupolar coupling of bromine nuclei.

W. Medycki^a, D. Kruk^b, A.F. Privalov^c, R. Jakubas^d, Wąsicki^e

^a*Institute of Molecular Physics, PAS, M. Smoluchowskiego 17, 60-179 Poznań, Poland*

^b*Institute of Physics, Jagiellonian University, Reymonta 4, 30-059 Krakow, Poland*

^c*Institut für Festkörperphysik, TU Darmstadt, Hochschulstr. 6, 64289 Darmstadt, Germany*

^d*Faculty of Chemistry, University of Wrocław, 50-383 Wrocław, Joliot Curie 14, Poland*

^e*Faculty of Physics, Adam Mickiewicz University of Poznan, Umultowska 85, Poland*

The organic-inorganic hybrid material containing imidazolium cation, $[\text{C}_3\text{N}_2\text{H}_5]_6[\text{Bi}_4\text{Br}_{18}]$, which has been used as an example, undergoes three solid-solid phase transitions: from phase I to II at 427/423 K (heating-cooling), II→III at 227 K and III →IV at 219.5/219 K.

Proton spin-lattice relaxation times have been measured for this compound in a broad temperature range from 80 K to 430 K (covering the phase transitions) at two magnetic fields 1.5 T and 2.1 T, corresponding to the proton Larmor frequencies of 58.9 MHz and 90 MHz. Relaxation dispersion was been measured for selected temperatures in the frequency range from 20 kHz to 110 MHz using fast field cycling and conventional NMR. In addition, testing measurements for selected temperatures have been done at the frequency of 100 MHz.

Bi-exponential proton magnetization decays observed for $[\text{C}_3\text{N}_2\text{H}_5]_6[\text{Bi}_4\text{Br}_{18}]$ at high magnetic fields are caused by strong quadrupolar interactions of Br nuclei affecting the relaxation of protons through mutual H-Br dipole-dipole couplings. A theoretical analysis of the effects of quadrupolar nuclei on the dipolar relaxation for the crystal under study is presented.

¹H NMR measurements disclosed the change in the motional state of the imidazolium cations through phase transitions at low temperatures. The ¹H NMR studies indicate that the biexponential proton magnetization decay in $[\text{C}_3\text{N}_2\text{H}_5]_6[\text{Bi}_4\text{Br}_{18}]$ may be caused by strong quadrupolar interactions of Br nuclei affecting the relaxation of protons through mutual H-Br dipole-dipole couplings.

This work has been partially supported by Grant N N202 172135 of Polish Ministry of Science and High Education.

^1H relaxation in complex fluids characterized by one- and two-dimensional distribution functions: Application to crude oil and asphaltene aggregation

*Martin D. Hürlimann, Lukasz J. Zielinski, and Denise E. Freed
Schlumberger – Doll Research, Cambridge MA, USA*

Many samples of interest are intrinsically complex or heterogeneous systems and show NMR relaxation that deviate significantly from mono-exponential decay. Examples include many biological, geological or food samples. In the absence of a detailed model for relaxation, it is useful to analyze the relaxation behavior in such systems in terms of non-negative distribution functions of the relaxation time, e.g. $f(T_1)$ and $f(T_2)$ for T_1 or T_2 relaxation, respectively. This approach can be extended to two-dimensional experiments such as T_1 - T_2 or diffusion- T_2 measurements. Similarly, it is useful to analyze field cycling data in terms of distribution functions.

The extraction of these distribution functions requires an inverse Laplace transformation, a mathematical procedure that is ill-conditioned. It is well known that this leads to intrinsic uncertainties in the distribution functions, i.e. the solution of the inversion procedure is not unique. By including an appropriate regularization term, stable solutions can be obtained that give new information about the system under study.

We have used this approach to study the relaxation properties of a series of different crude oils. These fluids are complex mixtures of hydrocarbons that have a wide range of molecular size and chemical properties. It is shown that distribution functions can give unique information that cannot be obtained from the measurement of average relaxation times alone. The presence of small amounts of asphaltene molecules (large aromatic molecules that easily aggregate) strongly affects the relaxation properties of the crude oils. In crude oils without asphaltene molecules, the average relaxation time is determined by the viscosity of the oil and the distribution of relaxation times is directly related to the distribution of molecular sizes of the oil components. Such oils can be identified by field cycling or T_1 - T_2 measurements, as they show no dispersion in field cycling experiments and the T_1 and T_2 distributions coincide.

When asphaltene molecules are present, they act as contrast agents and shorten the relaxation times of all oil molecules. By analyzing the shape of the distribution functions in field cycling experiments and in T_1 - T_2 measurements, we find that the asphaltene aggregates interact less strongly with the smaller oil molecules than with the larger ones. The analysis of this effect can be used to infer the size and state of the asphaltene aggregates.

Tridimensional molecular assembly of the major components of extra-virgin olive oils

P. Conte*, C. De Pasquale*, A. Maccotta**, E. Palazzolo*, D. Planeta*, G. Alonzo*

* *Dipartimento di Ingegneria e Tecnologie Agro Forestali, Università degli Studi di Palermo, v.le delle Scienze 13, ed. 4, 90128 Palermo, Italy pellegrino.conte@unipa.it*

** *Dipartimento di Fisica e Tecnologie Relative, Università degli Studi di Palermo, v.le delle Scienze 13, ed. 18, 90128 Palermo, Italy*

A number of extra-virgin olive oils were obtained by mechanical extractions from different Sicilian olive cultivars. High field NMR analyses showed, as expected, that the major components of the extra-virgin oils were triglycerides. The measurements of the proton longitudinal relaxation times (T_1) revealed that triglycerides were ellipsoidal-shaped. In fact, a multi-exponential mathematical model was applied to fit all the decay data from the classical inversion recovery experiments, thereby leading to the conclusion that anisotropic relaxation mechanisms arise into the triglycerides.

Low field NMR experiments revealed two different components of the longitudinal relaxation times. The shortest T_1 value was attributed to an intra-molecular spin diffusion, whereas the longest T_1 was assigned to inter-molecular spin diffusion mechanisms. According to such hypothesis, it has been concluded that triglycerides in extra-virgin olive oils are assembled in contiguous supramolecular blocks.

The present study showed for the first time that the combined use of different NMR techniques can be very helpful for obtaining information on the conformational assessment of natural systems such as extra-virgin oils. This is an important research issue in order to evaluate structure-activity properties of food materials which are recognised to have very relevant nutritional implications.

Acknowledgments. The authors are grateful to Centro Grandi Apparecchiature – Uninetlab of the Università degli Studi di Palermo for having provided machine time at the high field NMR spectrometer. This work was partially funded by Ce.R.T.A. s.c.r.l. (Centri Regionali per le Tecnologie Alimentari).

Recent progress in theory of field dependent relaxation and polarization transfer processes in multi-spin systems

^aDanuta Kruk, ^bJozef Kowalewski, ^cFranz Fujara, ^cAlexei Privalov, ^dWojciech Medycki

^aInstitute of Physics, Jagiellonian University, Reymonta 4, 30-059 Krakow, Poland

^bDepartment of Physical, Inorganic and Structural Chemistry, Stockholm University, S-106 91 Stockholm, Sweden

^cInstitut für Festkörperphysik, TU Darmstadt, Hochschulstr. 6, 64289 Darmstadt, Germany

^dInstitute of Molecular Physics, PAS, Smoluchowskiego 17, 60179 Poznań, Poland

One of the well known applications of the field cycling technique are studies of NMR spin-lattice relaxation rates as a function of the magnetic field (nuclear magnetic relaxation dispersion, NMRD) in solutions of paramagnetic ions or complexes. Recently, a theory of nuclear spin relaxation for nuclear spins interacting with electron spins, residing in other molecules (the outer-sphere relaxation), has been developed [1,2]. The approach, valid outside of the Redfield limit for electron spin relaxation, is an extension of the Swedish slow motion theory [3,4] for inner-sphere relaxation.

Employing the analogy between zero field splitting interactions for electron spins and quadrupolar interactions for nuclear spins a theory of field dependent relaxation in solid state systems, containing mutually coupled spins of spin quantum numbers $I = 1/2$ and $S \geq 1$ (possessing quadrupole moments), has been developed as a counterpart of the paramagnetic relaxation enhancement theory. As long as the nuclear spins with quadrupole moments are within the Redfield limit, the description is based on the second order perturbation theory [2, 5-7], while beyond the Redfield limit the idea of the Swedish slow motion theory has been adopted.

Analysis of the polarization transfer pattern (*i.e.* the $I = 1/2$ spin magnetization measured versus magnetic field) gives information on the quadrupolar parameters. Thus, polarization transfer and relaxation experiments provide complementary and unique information if properly evaluated. A complete theoretical description of polarization transfer effects has been recently given [2,7].

The goal of this lecture is to popularize these approaches with the intention to establish it as a standard tool for analysis relaxation data for complex molecular systems.

- [1] D. Kruk, J. Kowalewski, General treatment of paramagnetic relaxation enhancement associated with translational diffusion, *J. Chem.Phys.* – in press
- [2] D. Kruk, Theory of Evolution and Relaxation of Multi-spin Systems, Abramis Academic, Arima Publishing UK, (2007)
- [3] Benetis *et al.*, Nuclear-spin relaxation in paramagnetic systems-the slow motion problem for electron spin relaxation, *Mol. Phys.* 48, 329 (1983)
- [4] T. Nilsson, J. Kowalewski, Slow-motion theory of nuclear spin relaxation in paramagnetic low-symmetry complexes: A generalization to high electron spin, *J. Magn. Reson.* 146, 345 (2000)
- [5] D. Kruk, O. Lips, Field-dependent nuclear relaxation of spins 1/2 induced by dipole-dipole couplings to quadrupole spins: LaF₃ crystals as an example *J. Magn. Reson.* 179, 250 (2006)
- [6] D. Kruk, O. Lips, Evolution of solid state systems containing mutually coupled dipolar and quadrupole spins: Perturbation treatment SSNMR 28 (2-4), 180 (2005)
- [7] D. Kruk *et al.*, Field cycling methods as a tool for dynamic investigations in solid state systems: recent theoretical progress, *SSNMR*- in press

This work has been partially supported by Grant N N202 172135 of Polish Ministry of Science and High Education.

Nuclear magnetization evolution in time-variable magnetic fields: theory and exploitation

Stanislav Sykora, Extra Byte, Italy

The equilibrium state of nuclear magnetization is quite easy to derive from the spin Hamiltonian and from basic principles of statistical physics and thermodynamics. Somewhat less straightforward is the behavior of nuclear magnetization in imposed magnetic fields which vary either in magnitude or in direction or both. In such non-equilibrium conditions, one has to bring into the picture the dynamics of the spin system as described by its Larmor frequencies and its longitudinal and transverse relaxation times, all of which are themselves functions of the varying magnetic field.

Some of the possible limit situations which can arise had been analyzed and are described in the literature. These certainly include (i) the formation of a new equilibrium after a sudden jump in the magnitude of the external magnetic field (without changing its direction), (ii) a slow rotation of the external field (adiabatic lock) and (iii) under certain special conditions, a slow change in both the magnitude and the direction of the field (adiabatic switching).

Some of the phenomena arising in these contexts have even been actively exploited in MRI and observed in fast-field-cycling (FFC) NMR relaxometry. In the latter discipline they may be of crucial importance when switching the external field down to what are the typical values of local magnetic fields within the sample and/or the background magnetic fields in the laboratory (“earth field” in common jargon). Even more striking phenomena are expected and observed when switching across the null field (field inversion) but they have never been pursued due to their apparent complexity.

This presentation concerns a unified treatment of the behavior of nuclear magnetization in variable magnetic fields, describes explicit solutions available for some special cases, and uses numeric simulations to illustrate others. The theory explains, first of all, how comes that it is possible to use the FFC-NMRD method to measure relaxation times over an order of magnitude shorter than the shortest available field-switching times. It also provides a method to optimize the FFC-NMR signal intensity by using appropriate field switching waveforms.

Even more interesting is the possibility to apply the theory to field switching down to nominal values which are close to zero, and even to main-field zero-crossing into “negative” values. The resulting complex phenomena depend strongly upon the sequence timing (including the switching rates and waveforms) which, in principle, is fully under our control, and upon the static and dynamic characteristics of the local magnetic fields inside a sample. Their quantitative analysis should therefore permit us to study the latter. Though this part of the theory is still under development, the perspectives are very encouraging.

Investigation of field dependency of contrast for DIACEST peptides
Guanshu Liu^{1,2}, Assaf. A. Gilad^{1,3}, Jeff W.M. Bulte^{1,3}, Peter C.M. vanZijl^{1,2}, Michael T. McMahon^{1,2}

¹The Russell H. Morgan Department of Radiology, Johns Hopkins School of Medicine, Baltimore, MD, United States, ²F.M. Kirby Center, Kennedy Krieger Institute, Baltimore, MD, United States, ³Institute for Cell Engineering, Johns Hopkins School of Medicine, Baltimore, MD, United States

Recently, Chemical Exchange Saturation Transfer (CEST) has emerged as a novel contrast mechanism for MRI with "multiple-color" ability, with the multiple colors corresponding to different saturation frequency dependencies of the CEST contrast. However, the impact of B_0 field strength on CEST contrast is still not well characterized. Herein, the CEST effects for a series of 17 peptides were investigated at 4 different field strengths (4.7 Tesla, 9.4 Tesla, 11.7 Tesla and 17.6 Tesla). These 17 peptides contained different combinations of three of the major types of naturally occurring exchangeable protons, NH, NH₂ and OH, which have been demonstrated to produce detectable CEST contrast at 3.6 ppm, 1.8 ppm and 0.8 ppm respectively. Such a peptide library represents a prototype for the development of new CEST agents that can be selectively detected using different CEST offsets. The experimental data was also compared to the theoretical predictions for 2-pool or 3-pool exchange models derived from the Bloch equations. The increase in T₁ relaxation time has been assigned to be the dominant factor for boosting CEST contrast at higher fields. This study will greatly facilitate the development of high field molecular imaging studies using novel CEST contrast agents for MR imaging.

Spin-lattice relaxation dispersion in polymers: Dipolar-interaction components and short- and long-time limits

N. Fatkullin¹, A. Gubaidullin¹, T. Shakirov¹, R. Kimmich²

¹Kazan State University, Department of Physics, Kazan 420008, Tatarstan, Russia

²University of Ulm, Sektion Kernresonanzspektroskopie, 89069 Ulm, Germany

The Mori-Zwanzig projection operator technique was employed to derive the effective Hamiltonian for spin-segment coupling. The fluctuations of this operator are responsible for spin-lattice relaxation in polymer chains. In detail, dipolar interaction of spins is rigorously analyzed by components representing fluctuations of the Kuhn segment end-to-end vectors and local fluctuations on a length scale shorter than the root mean square Kuhn segment length. The former correspond to the usual coarse-grain picture of polymer chain mode theories. It is shown that these non-local chain modes dominate proton spin-lattice relaxation dispersion of flexible polymers at frequencies up to about 10^8 Hz. A corresponding evaluation of experimental data for polybutadiene melts is presented.

This work was financially supported by RFBR.

References:

1. A. Gubaidullin, T. Shakirov, N. Fatkullin, R. Kimmich, Spin-lattice relaxation dispersion in polymers: Dipolar-interaction components and short- and long-time limits, *Solid State NMR* (*in press*, doi:[10.1016/j.ssnmr.2008.10.004](https://doi.org/10.1016/j.ssnmr.2008.10.004))

Universal polymer dynamics revealed by fast field cycling ^1H NMR

A. Herrmann, A. Abou Elfadl, R. Meier, S. Kariyo, V.N. Novikov,
E.A. Rössler, *Experimentalphysik II, Universität Bayreuth, 95440 Bayreuth, Germany*

We apply fast field cycling ^1H NMR to study segmental reorientation dynamics in melts of linear polybutadiene (PB), polyisoprene (PI) and polydimethylsiloxane (PDMS) in the high molecular weight (M) limit. Measuring fully protonated as well as partially deuterated polymers we show that in contrast to previous reports the relaxation behavior at low frequencies, for which polymer-specific contributions show up, is not universal but depends on the particular inter-nuclear vectors of the ^1H spin pairs in the monomer unit. This is demonstrated when the dispersion data $T_1(\omega)$ for each polymer (cf. Fig. 1a) is transformed into the susceptibility representation $\chi''(\omega) = \omega T_1$. Assuming frequency-temperature superposition master curves are constructed from the data measured at different temperatures by plotting $\chi''(\omega\tau_s)$, where τ_s denotes the segmental correlation time (cf. Fig. 1b). Compared with the behavior of a simple liquid (o-terphenyl or PB466) the polymer contribution at $\omega\tau_s \ll 1$ is strongest in PB-h₂ and smallest in PI. Moreover, the datasets from differently protonated PB samples (PB-h₂, PB-h₄, PB-h₆) significantly differ. Only after extracting the polymer specific contributions from the overall spectra by subtracting the glassy contribution obtained from studying the low M limit of the polymer, the resulting normalized “polymer spectra” reveal universal behavior which can be described by two power law regimes, one attributed to free Rouse dynamics and one, at lower frequencies, to entanglement effects (cf. Fig. 1c). In the frequency range currently accessible by FCC-NMR we neither can confirm the prediction by the tube-reptation nor those of the re-normalized Rouse theory.

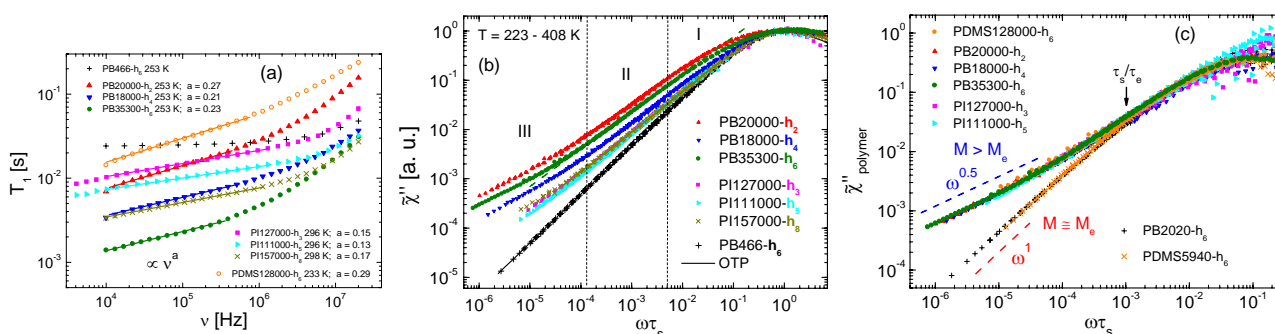

Fig. 1. (a) T_1 -Dispersion data for various polymers. (b) Corresponding susceptibility master curves. (c) Universal “polymer spectra” after subtracting glassy spectrum.

In the case of PB-h₆, we also investigated the crossover from the low M to the high M limit. We extended our previous results to lower frequencies and obtain the total correlation function (cf. Fig. 2) containing contributions from both polymer and glassy dynamics by Fourier transform of master curves $\chi''(\omega\tau_s)$.

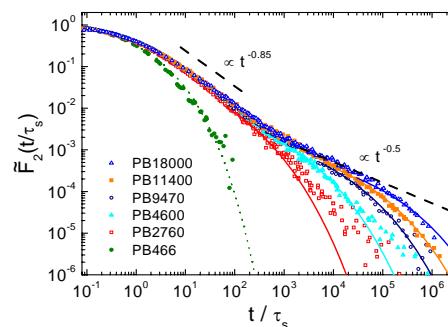

Fig. 2. Dipolar correlation function showing the crossover from Rouse to entanglement dynamics, the latter being characterized by a bimodal shape.

References

Kariyo et al. *Macromolecules* **2008**, 41, 5313-5321. Dito 41, 5322-5332
Herrmann et al. *Macromolecules* **2009**, 42, 2063-2068. Dito submitted.

Crossover from 3D to 2D melt in thin films studied by FFC-NMR

Santhosh Ayalur-Karunakaran¹, Siegfried Stapf²

¹Dept. of Macromolecular Chemistry, ITMC, RWTH Aachen, 52074 Aachen, Germany

²Dept. of Technical Physics II, TU Ilmenau, PO Box 100565, 98684 Ilmenau, Germany

It is well known that the dynamical properties of confined polymers differ from those of their bulk counterparts owing to the geometrical restriction. Earlier studies have confirmed for polymers adsorbed in a nanoscopic confinement, the relaxation dynamics studied using FFC could vary from a reduction in relaxation times to a complete qualitative change from bulk dynamics, depending on the dimensions of the restrictions^{1,2}. However, the partially confined state, i.e. polymer forming a thin film inside these confinements, is much less investigated³. It is obvious that upon reducing the thickness of the layer, the melt behaves no more like a 3D liquid but rather a 2D liquid. It is of interest to see how and when this transition occurs in such adsorbed thin films, and how it manifests in the observed relaxation dynamics.

In this study, Poly (dimethyl siloxane) forming weakly adsorbed thin films inside a porous alumina membrane was studied as a function of layer thickness and molecular weight. While all films showed a reduction in mobility, the thinnest films showed a deviation from bulk with an increased slope. The solid echo measurements confirmed that deviations from bulk in relaxation dispersion occur when the short component is the dominant contribution.

The results are interpreted as an interplay between contributions arising from two regions, one closer to the air-interface where chains are restricted due to connectivity with segments that are adsorbed showing a reduced bulk-like behaviour, and another region close to the solid interface, where chains are restricted due to adsorption effects (or adsorption restricted layer) and show altered mobilities. Deviations from bulk behaviour become notable in longitudinal relaxation when layer thicknesses are much less than the chain size (Radius of gyration, R_g), when the contribution from adsorption reduced layer dominate accompanied by a possible change in chain conformation.

1. R. Kimmich et al, Chem. Phys. Lett. **1999**, 307,147.
2. R. Kausik, C. Mattea, N. Fatkullin, R. Kimmich, J.Chem. Phys. **2006**, 124, 114903.
3. S. Ayalur-Karunakaran, B. Blümich, S.Stapf, EPJ E **2008**, 26, 43.

Valentina Domenici ^{1,*}, Mario Cifelli ¹, Carlo Alberto Veracini ¹,Natalia Boiko ², Elena Agina ², Valery Shibaev ²

1) Dipartimento di Chimica e Chimica Industriale, Università di Pisa, Via Risorgimento 35, 56126, Italy; 2) Moscow State University, Chemistry Department, Moscow 119992, Russia.

A ^2H NMR relaxation study performed on a partially deuterated liquid crystalline carbosilane dendrimer (G-3(Und-R)₃₂) is here reported. The dendrimer under investigation (see Scheme 1A) shows a SmA phase in a large temperature range from 381 K to 293 K and its mesophasic as well as orientational ordering properties have been previously investigated [1].

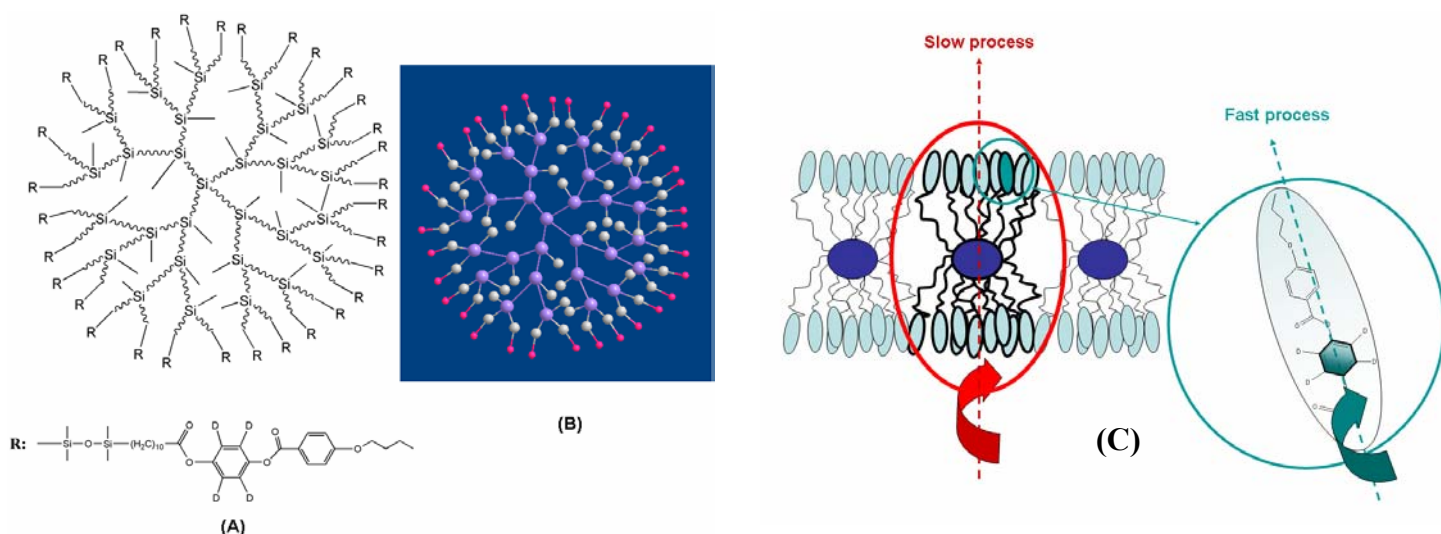

Scheme 1: (A) Molecular structure of the LC dendrimer G-3(Und-R)₃₂ and its lateral group R; (B) dendrimer in the isotropic phase; (C) two main motional contributions to the ^2H NMR relaxation.

^2H NMR spin-lattice relaxation times, T_{1Z} and T_{1Q} , and spin-spin relaxation times measured by means of the quadrupolar echo sequence, T_2 , have been analyzed in order to get information about the dynamic processes active in the SmA phase of this liquid crystalline dendrimer. The trend of the measured relaxation times pointed out a slowing down of the dynamics by decreasing the temperature which determines from on side the spectral changes observed in the ^2H NMR spectra, on the other the observation of a minimum in the T_1 . Several theoretical models describing both internal and overall molecular motions have been used to fit the experimental spectral densities $J_0(0)$, $J_1(\omega)$ and $J_2(2\omega)$. This quantitative analysis [2] indicates that two rotational motions mainly contribute to the observed relaxation: the internal rotation of the deuterated aromatic ring around its *para* axis (“fast process”) mainly contributes to the longitudinal relaxation times and a motion ascribable to the whole dendritic molecule (“slow process”) affects the transverse relaxation (see Scheme 1C).

[1] Domenici, V.; Cifelli, M.; Veracini, C. A.; Agina, E. V.; Boiko, N. I.; Shibaev, V. P. *J. Phys. Chem. B*, 2008, 112, 14718. 3.

[2] Domenici, V. *Phys. Chem. Chem. Phys.*, under review.

NMR relaxation study of molecular dynamics of liquid crystalline side-on organosiloxane tetrapodes

D. Filip^{a, b}, C. Cruz^{a, c}, P.J. Sebastião^{a, c}, M. Cardoso^a, A. C. Ribeiro^{a, c},
M. Vilfan^d, T. Meyer^e, P. H. J. Kouwer^e, G. H. Mehl^e

a CFMC-UL Av. Prof. Gama Pinto 2, 1649-003 Lisboa, Portugal

b “Petru Poni” Institute of Macromolecular Chemistry, Aleea Gr. Ghica
Voda 41A, 700487-Iasi, Romania

c IST-UTL, Av. Rovisco Pais 1049-001 Lisboa, Portugal

d Jozef Stefan Institute, Jamova 39, 1000 Ljubljana, Slovenia

e Dep. Chemistry, University of Hull, Cottingham Road, Hull HU6 7RX,
United Kingdom

Proton NMR relaxation measurements were carried out on two liquid crystalline organosiloxane tetrapodes with side-on mesogenic groups, exhibiting nematic and smectic C phases, and on a monomeric analogue.^{1,2} NMR relaxometry of the tetrapodes systems yields T_1^{-1} dispersions clearly different from those of conventional calamitics. The influence of molecular tendency to form interdigitated structures is evidenced by frequency dependent relaxation rate in the isotropic phase – indicating the presence of ordered clusters far above the phase transition – and by the diminished role of molecular self-diffusion in ordered phases. Nematic-like director fluctuations are the dominating relaxation mechanism whereas the translational displacements are strongly hindered by the interdigitation of dendrimer arms.

(1) K. Merkel, A. Kocot, J.K. Vij, R. Korlacki, G.H. Mehl, and T. Meyer, *Phys. Rev. Lett.* **2004**, *93*, 237801

(2) D. Filip, C. Cruz, P.J. Sebastião, A. C. Ribeiro, T. Meyer, G. H. Mehl, *Mol. Cryst. Liq. Cryst.* **2005**, *436*, 17

Molecular Dynamics of Ionic Liquids Studied by NMR relaxometry

Carlos Mattea and Siegfried Stapf

Technische Physik II / Polymerphysik, Institute für Physik,
Fakultät für Mathematik und Naturwissenschaften, TU Ilmenau, 98684 Ilmenau,
Postfach 10 05 65, Germany.

Low melting organic salts, commonly referred to as ionic liquids (ILs) constitute a novel class of chemicals. They have been discovered in the last decades and since then receiving much attention as “green” replacement of common solvents in chemical technology [1].

Their physico-chemical properties like negligible volatility, nonflammability, chemical and thermal stability and high ionic conductivity, can be easily tuned due to the great number of combinations between anions and cations and/or simply by changing the structure of the components ions.

They reveal different properties from the common molecular liquids mainly due to their ionic character. In this context, there is much interest in the study of their molecular motions that control transport properties in these materials [1]. Reorientation and translational dynamics can be suitably studied by Nuclear Magnetic Resonance (NMR).

In this contribution the results of NMR relaxometry [2] experiments on imidazolium derivatives ILs [1] are shown. ILs of this type have the advantage that ^1H - and ^{19}F nucleus are found respectively, in their cations and anions constituents. This allows the study of each ion individually just selecting the respective nuclei. T_1 relaxation was measured at different temperatures in the frequency range from 10 kHz to 30 MHz with a Stellar FFC relaxometer and complemented with a relaxation value at 300 MHz with a conventional Bruker Spectrometer.

The dynamics of the different ions (cation and anion) revealed by the T_1 dispersion curves are qualitatively similar, showing only differences in the absolute value of its longitudinal relaxation time. The data can be correlated with the translational dynamics obtained via diffusion measurements [3].

Acknowledgements

We acknowledge Stephan Krischok from TU Ilmenau for providing the samples.

References

1. P. Wasserscheid, T. Welton (Eds.), *Ionic Liquids in Synthesis*, VCH-Wiley, Weinheim, 2003.
2. R. Kimmich, *NMR Tomography, Diffusometry and Relaxometry*, Springer (1997).
3. H. Tokuda et al, *J. Phys. Chem. B*, 109 (2005), 6103.

Low field time-resolved Dynamic Nuclear Polarization with field cycling and high resolution NMR detection

A. S. Kiryutin,^{a,b} S. E. Korchak^a, K. L. Ivanov,^{a,b} A. V. Yurkovskaya,^{a,b} H.-M. Vieth^a
^a Institut für Experimentalphysik, Freie Universität Berlin, Arnimallee 14, D-14195 Berlin, Germany

^b International Tomography Center, Institutskaya 3a, Novosibirsk, Russia

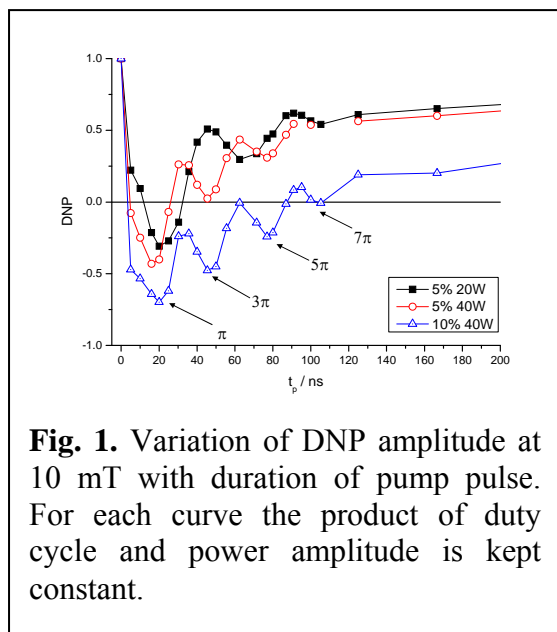

Fig. 1. Variation of DNP amplitude at 10 mT with duration of pump pulse. For each curve the product of duty cycle and power amplitude is kept constant.

Using pulsed double-resonance electron-nuclear techniques with stable radicals is a promising approach to enhance the sensitivity of NMR *in vivo* and *in vitro*. Here the results of our studies of the efficiency of polarization transfer from the electronic to the nuclear spin reservoir in liquid state Dynamic Nuclear Polarization (DNP) for pulsed pumping of EPR transitions will be presented. EPR pumping was performed at low field. By means of fast field-cycling the sample was transferred to high field where the high-resolution NMR spectrum was obtained. Fast field-cycling was carried out by utilizing a device that shuttles the whole NMR probe allowing high-resolution NMR detection at high field (7 T). We have studied the proton DNP of water and samples containing 3-furoic acid and histidine

in aqueous solution with stable nitroxide radicals (TEMPOL) at 300 MHz ($B=10$ mT) and 1500 MHz ($B=54.6$ mT). The dependence of DNP on the duration of the pumping pulse, RF-power and duty cycle was analyzed. In comparison with *cw*-pumping a substantial gain in polarization was achievable. When the pulse duration τ_p corresponds to flip angles of odd multiples of π the DNP efficiency goes through a maximum showing that coherent electronic spin motion can be exploited. This is demonstrated in Fig. 1, where the DNP amplitude is plotted as a function of the width of the pumping pulse while the average pumping power (power amplitude \times duty cycle) is kept constant. Because of B_1 inhomogeneities and relaxation effects the first π -pulse yields the highest efficiency. For optimum power utilization the pulse repetition rate t_D^{-1} should be smaller than the electronic spin-lattice relaxation rate T_{1e}^{-1} . From the dependence of the DNP amplitude on t_D^{-1} we determined an effective paramagnetic time of 716 ± 44 ns for TEMPOL at 10 mT. Other pulse schemes will be discussed. Also, the effect of the TEMPOL concentration on the relaxation times T_{1n} of individual protons and its magnetic field dependence was studied in the field range 0-7 T. Theoretical and numerical models were developed to calculate and optimize the polarization transfer from electron to nuclear spins by *cw* and pulsed radiofrequency irradiation. Combining these results the strategy for optimal conditions for pulsed DNP at low field was established.

Financial support by the Sixth Framework Programme of the European Community via Bio-DNP grant No. 011721 and Marie Curie Actions program (project MIF2-CT-2006-02208), the Russian Fund for Basic Research (projects No. 08-03-00539-a, 09-03-00837-a) is gratefully acknowledged. K.L.I. acknowledges support from the Alexander von Humboldt Foundation.

Tunnelling magnetic resonances: DNP and the diffusion of methyl group tunnelling energy studied by field cycling NMR

A.J. Horsewill and C. Sun

School of Physics & Astronomy, University of Nottingham, Nottingham, NG7 2RD, UK

Methyl rotors (CH_3) exhibit coherent quantum tunnelling with a characteristic frequency. When an electron spin Larmor frequency is brought into resonant contact with a tunnelling methyl group, dynamic nuclear polarisation (DNP) of the protons in the sample is observed. This striking response of the nuclear polarisation arises as energy flows between the CH_3 tunnelling reservoir and the electron spin Zeeman reservoir. The mechanism underlying the evolution of this DNP has been investigated in a new series of field-cycling NMR experiments together with numerical simulations.

In single crystal samples of Cu^{2+} doped zinc acetate we find that the DNP arises from two processes; a) direct contact between the electron spin and the tunnelling reservoir, the proton spin transitions being driven by electron-proton dipolar interactions rendered time-dependent by the tunnelling motion, b) spectral and spatial diffusion of tunnelling energy through the lattice, there existing a distribution of tunnelling frequencies.

The time constants characterising a) the slow release of energy from the tunnelling reservoir and b) the diffusion of tunnelling energy between methyl groups have been measured and a computer model has been developed to simulate the processes involved. The DNP lineshapes and their time-dependence have been investigated experimentally and are emulated well by the computer model. The investigation, conducted at low temperature, gives insight into the fundamental processes underlying the quantum motion of molecules and the exchange of energy between thermal reservoirs associated with different subsystems embedded in the lattice.

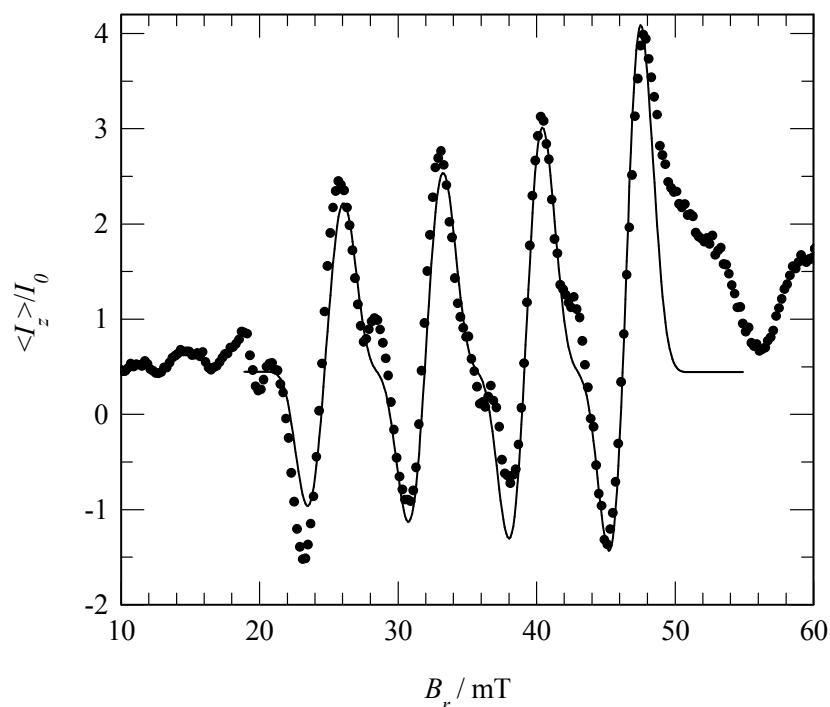

Figure: CH_3 tunnel resonance displaying DNP in Cu^{2+} doped zinc acetate

Lukasz J. Zielinski and Martin D. Hürlimann
Schlumberger-Doll Research, One Hampshire Street, Cambridge, MA 02139

Crude oils are natural complex fluids composed of mixtures of hydrocarbons of different sizes and molecular composition, ranging from the simplest, such as methane, to long-chain waxy alkanes to heavy resin and asphaltene molecules consisting of multiple fused aromatic rings with attached alkane chains. Their low-field proton relaxation is intrinsically multi-exponential as different crude components relax with different characteristic times. Thus, distributions of relaxation rates must be considered in order to provide a more complete description of the fluid. A simple BPP theory that approximates each tumbling molecule in a mixture as a hard sphere and relates its relaxation rate to the sphere's radius is not appropriate. For conventional crude oils (C5-C30, mostly alkane mixtures), a polymer-like model was developed that maps the distribution of relaxation rates onto the distribution of alkane chain lengths. In heavy crude oils, however, which in addition to alkanes contain a significant fraction of resins and asphaltenes, the dynamics – and thus the relaxation characteristics – of the different oil components will be much more complicated as they will depend on the aggregation state of resins and asphaltenes as well as on the propensity of a given oil molecule to interact with the aggregates.

To study such interactions and gain an idea of the sizes of any resin-asphaltene aggregates present, we have used field cycling to examine the evolution of the distributions of relaxation rates in crude oils with changing Larmor frequency. Panel (a) in the Figure shows an example of a *deasphalted* crude oil, i.e., with the heaviest fraction removed. The appearance of dispersion signals the presence of correlation times of the order of 200 ns, corresponding to aggregates with a hard-sphere radius of ~ 1.5 nm, which is much larger than the sizes of molecules found in conventional oils. The fact that the short- T_1 tail of the distribution broadens for lower fields is an indication that the larger molecules in the oil are more strongly affected by the presence of the aggregates than the smaller molecules.

Panel (b) of the Figure shows the change in the dispersion of the mean relaxation rate (averaged over the entire distribution) upon addition of large asphaltene molecules to the deasphalted crude oil shown in panel (a). Black circles correspond to the deasphalted oil, while squares and triangles correspond to that same oil with different amounts of dissolved asphaltene. The divergence at small frequencies is expected and can be explained by the presence of correlation times longer than $100 \mu\text{s}$ associated with the added asphaltene. The remarkable fact is that relaxation at frequencies higher than 2 MHz is almost unchanged, consistent with the notion that fast-moving smaller molecules, or segments of molecules, are little affected by asphaltene aggregates. The solid line is a fit to a new model developed recently to describe the interactions of smaller crude oil components with large resin-asphaltene aggregates. The model can be used to extract sizes of the aggregates.

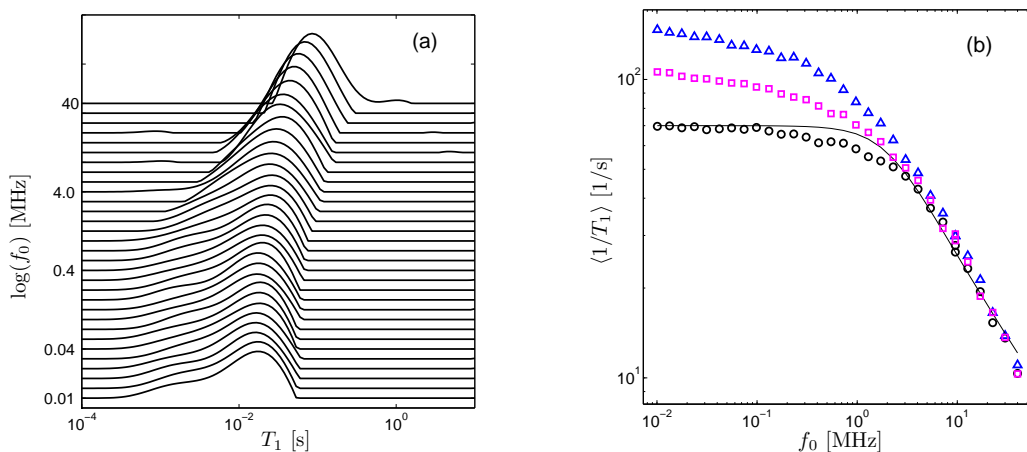

FIG. 1: (a) Evolution of the distribution of T_1 relaxation for a deasphalted crude oil. (b) Dispersion of mean relaxation rates for the deasphalted oil (black circles) and for that same oil with different amounts of dissolved asphaltene (squares and triangles).

Behavior of monovalent metal cations inside a calixarene cavity as probed by nuclear spin relaxation. Evidence of cation- π interactions in water.

Sabine Bouguet-Bonnet⁽¹⁾, Diana Cuc⁽¹⁾, Nicole Morel-Desrosiers⁽²⁾, Jean-Pierre Morel⁽²⁾, Pierre Mutzenhardt⁽¹⁾, Daniel Canet⁽¹⁾

¹ Cristallographie, Résonance Magnétique et Modélisation, équipe Méthodologie RMN, Nancy-Université, CNRS, Faculté des Sciences et Techniques, BP 239, 54506 Vandoeuvre-lés-Nancy Cedex, France.

² Microorganismes : Génome et Environnement, Clermont Université, CNRS, Chimie Bât. 7, 24 avenue des Landais, 63177 Aubière Cedex, France.

ABSTRACT

We present here a study of the complexation of monovalent metal cations (cesium and thallium) by a calixarene cavity. This study rests exclusively on multifield spin relaxation. The first parameter to determine is the correlation time describing the calixarene tumbling. We show that this is easily achieved by measuring the longitudinal relaxation time of a carbon-13 bearing a proton at only two frequencies. Knowing this correlation time, it proved possible to determine the chemical shift anisotropy (csa) variations when going from free calixarene to its complex form. Again, longitudinal relaxation times of three aromatic (non bearing proton) carbons-13 measured at only two frequencies were found convenient for such a determination. As a matter of fact, these csa variations provide invaluable information about the cation location within the calixarene cavity and about the nature of interactions. These results are complemented by cesium and thallium relaxation measurements, again at two values of the magnetic field. An estimation of the mean distance between the cation and the calixarene protons could be obtained. These measurements have also revealed important chemical shift anisotropy of thallium upon complexation.

Electron paramagnetic resonance of Gd_2O_3 - nanoparticles

Gustafsson H¹., Söderlind F²., Ahrén M²., Käll P.-O²., Uvdal K²., Engström M¹.

¹ Center for Medical Image Science and Visualization (CMIV),

² Department of Physics, Chemistry and Biology, IFM,
Linköping University, SE-581 85 Linköping, SWEDEN

MRI contrast agents, which are paramagnetic, superparamagnetic, or ferromagnetic compounds, provide additional image contrast by shortening the relaxation times of the hydrogen atoms from water present in tissue. Gadolinium (III) chelates and superparamagnetic iron oxid (SPIO) nanoparticles are the contrast agents most commonly used in clinical MRI. In recent years there has been an increasing interest for the possibility of *in vivo* cell tracking and the possibility to study molecular processes *in vivo* (molecular imaging), using MRI. SPIO nanoparticles provide strong negative (dark) contrast best seen in T_2 - weighted images and has been successfully used for e.g. for tracking transplanted cells in various organs. However, for many applications it could be difficult to distinguish SPIO labelled cells from other hypointense (dark) regions. While gadolinium (III) chelates provides positive contrast with most pulse sequences, the relative weak signal intensity enhancement of gadolinium (III) chelates makes them less suitable for molecular imaging and cell tracking. We have recently showed that Gd_2O_3 nanoparticles at least doubled the relaxivity compared to the commonly used gadolinium (III) chelate Gd-DTPA. In order to explore the physical mechanisms behind this strong positive contrast of Gd_2O_3 - nanoparticles, we have used electron paramagnetic resonance (EPR) to provide information about the electron spin system. With the aim to further increase the relaxivity we have studied how the transverse relaxation time ($T_{2,e}$) of Gd_2O_3 - nanoparticles is affected by increased concentrations of Y_2O_3 in the nanoparticles. The EPR line shape was found to be dependent on the Y_2O_3 concentration with decreased EPR line widths for increased Y_2O_3 concentrations indicating an increasing $T_{2,e}$ as shown in the figure below. This experiment therefore suggests that diluting the Gd_2O_3 - nanoparticles with Y_2O_3 could influence the relaxivity by means of altered electron relaxation times. Further experiments are planned in order to measure relaxivity in water solution using a clinical MRI scanner.

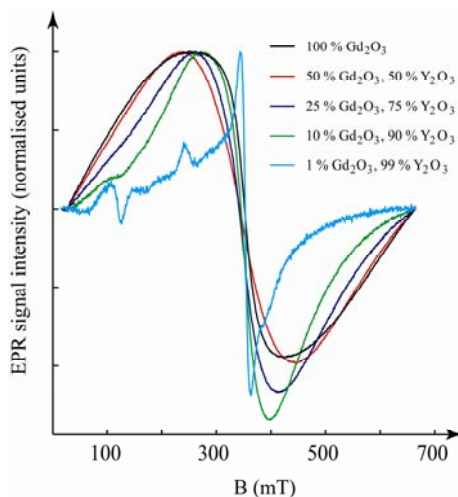

Poster

Protein and cell water dynamics on a wide range of time scales

Erik Persson & Bertil Halle

Department of Biophysical Chemistry, Center for Molecular Protein Science, Lund University

Because of the complexity of the underlying free energy landscape, the internal dynamics of the proteins span a wide range of time scales. Much of the available information about these dynamics comes from methods that exploit nuclear relaxation phenomena. In solution, all anisotropic nuclear spin couplings are averaged to zero by protein tumbling, so the spin relaxation induced cannot report on internal motions slower than the protein tumbling time of, typically, several nanoseconds. Much slower motions can be detected via their effect on the isotropic chemical shift, but this still leaves a significant time scale gap that cannot be probed directly by solution NMR relaxation and that is not yet accessible by conventional molecular dynamics simulations.

Immobilizing the protein with a chemical crosslinker produces gels containing more than 90% water where the protein tumbling is inhibited. This allows slower internal motions to be studied via quadrupolar spin relaxation. We monitor the protein dynamics via relaxation effects on the water ^2H and ^{17}O resonances, conveyed by internal water molecules which experience an isotropic system. By recording the Larmor frequency dependence of the spin-lattice relaxation rate, the so-called magnetic relaxation dispersion (MRD), and using a generalized relaxation theory that remains valid for arbitrarily slow molecular dynamics, we can directly determine the residence times of individual water molecules at crystallographically identified internal sites.

We have also studied the crowded cytoplasmic milieu of living cells by *in vivo* $^2\text{H}/^{17}\text{O}$ MRD. Using a model-free analysis, we conclude that about 90% of the cell water has bulk-like dynamics. The remaining 10%, which interact directly with biomolecular surfaces, are motionally retarded by a factor 15–20 relative to bulk water. The MRD data also show that a small fraction (0.1%) of the cell water exchanges from buried hydration sites on time scales up to 10 ms. Our findings contradict the view that a substantial fraction of cell water differs greatly from bulk water. The $^2\text{H}/^{17}\text{O}$ MRD technique and theoretical analysis used here open up new possibilities for studying water dynamics *in vivo* and for elucidating the origin of endogenous contrast in magnetic resonance images of soft tissue.

¹H NMR relaxometry of a rod-like chiral liquid crystal in its isotropic, cholesteric, TGBA* and TGBC* phases

T. Apih,^a V. Domenici,^{a,b} A. Gradisek,^a V. Hamplová,^c P. J. Sebastião,^d M. Vilfan^a

^a Department of Solid State Physics, Jožef Stefan Institute, Jamova 39, 1000 Ljubljana, Slovenia; ^b Dipartimento di Chimica e Chimica Industriale, via Risorgimento 35, 56126 Pisa, Italy; ^c Institute of Physics, Academy of Sciences of the Czech Republic, Na Slovance 2, 182 21 Prague, Czech Republic. ^d Centro de Física da Matéria Condensada, Complexo Interdisciplinar da Universidade de Lisboa, Av. Prof. Gama Pinto, 2 - P-1649-003 Lisboa, Portugal.

The molecular dynamics of a chiral liquid crystal, showing a rich variety of frustrated mesophases, has been investigated by means of ¹H NMR relaxometry. The molecular structure of this mesogen, denoted as **HZL 7/***, is reported in Figure 1. The interest in this compound is related to the large range of thermal stability of the rare twist grain boundary phases, non-tilted (TGBA*) and tilted (TGBC*) ones.[1]

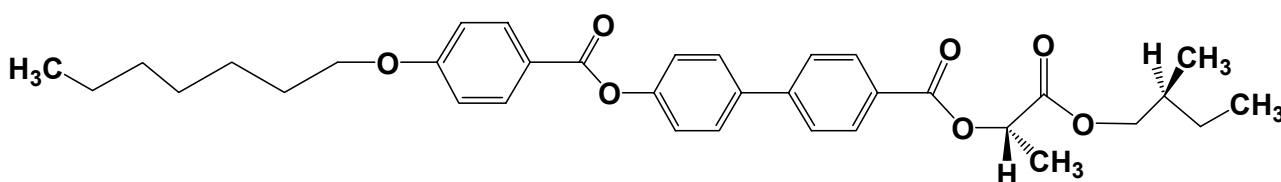

Figure 1: Molecular structure of the chiral liquid crystal **HZL 7/***.

Though structural and orientational studies on the TGB phases [2] have been performed by means of different theoretical and experimental methods, only a few dynamic investigations are known up to now.[3] In this work, ¹H spin-lattice relaxation times T_1 have been measured as a function of frequency, from 16 MHz to 5 kHz, in the whole mesophasic range from the isotropic to the TGBC* phases. A peculiar behaviour has been observed at the transition between the cholesteric N* and TGBA* phases at low frequencies, where a minimum in the T_1 vs temperature has been detected in the N* phase, followed by a strong increase upon the onset of the TGBA* phase. In the TGB phases T_1 decreases by decreasing temperature, showing a discontinuity at the transition TGBA* - TGBC* at frequencies lower than 100 kHz. The analysis of the T_1 relaxation dispersions based on different relaxation mechanisms for the studied mesophases will be reported and discussed in relationship with the previous NMR investigations on the **HZL 7/*** mesogen.[4]

- [1]. V. Novotna, M. Kaspar, V. Domenici, V. Hamplova, M. Glogarova, P. Bilkova, D. Pocieca, *Liq. Cryst.*, 2008, **35**, 287. [2]. J. W. Goodby, *Current Opinion in Colloid and Interface Science*, 2002, **7**, 326. [3]. J. L. Figueirinhas, A. Ferraz, A. C. Ribeiro, F. Noak, H. T. Nguyen, *J. Phys. II France*, 1997, **7**, 79. [4]. V. Domenici, C. A. Veracini, V. Novotna, R. Y. Dong, *ChemPhysChem*, 2008, **9**, 556.

SmC* liquid crystalline phases

Valentina Domenici^{a}, Alberto Marini^{a,b}, Carlo Alberto Veracini^a, Corrado Malanga^a, Rita Menicagli^a*

^a *Dipartimento di Chimica e Chimica Industriale, Università degli studi di Pisa, via Risorgimento 35, 56126 Pisa, Italy;* ^b *Scuola Normale Superiore di Pisa, Piazza dei Cavalieri 7, 56126 Pisa, Italy;*

In this work, the molecular dynamics of a ferroelectric liquid crystal, denoted as **ZLL 7/**, has been investigated by means of ^2H NMR relaxation. The spin-lattice relaxation times, T_{1Q} and T_{1Z} , and the spin-spin relaxation times, T_2 , of two isotopomers of **ZLL 7/**, labeled on the phenyl and biphenyl fragments have been measured and their behavior passing from the *SmA* to the *hexatic* phase, through the ferroelectric *SmC**, antiferroelectric *SmC*_A* and re-entrant ferroelectric *SmC*_re* phases, is here discussed. The comparison between the measured T_2 and the T_2^* , directly related to the experimental spectral line-width, provides information on the heterogeneity of the directors' distribution allowing us to confirm previous hypotheses [see ref. *J. Phys. Chem. B* **2006**, *110*, 16459] concerning the structural and ordering properties of the *SmC*_A* and *SmC*_re* phases. Moreover, the possibility to look at different sites of the core of the **ZLL 7/** smectogen revealed a peculiar behavior of the phenyl moiety, with respect to the biphenyl one, which has been here explained in terms of its vicinity of the chiral centers. Interestingly, the trend of the longitudinal relaxation times is characterized by a minimum in correspondence of the *SmC*_A* phase, which is reproducible for the two isotopomers and at several Larmor frequencies. A quantitative analysis of T_{1Q} and T_{1Z} was performed in the *SmA* and *SmC** phases, where the narrowing regime approximation is valid. Here, a multi-frequency approach was applied in order to self-consistently determine the diffusion coefficients for the overall molecular spinning, tumbling, internal rotations around the *para* axes of the phenyl and biphenyl fragments and the contribution of the collective motions to the relaxation processes.

The effect of the magnetic field, H , in unwinding the helical supramolecular structure of the *SmC** phase (for $H > 9$ T) allowed us to observe a sensitive change in the rotational diffusion coefficients in the frustrated unwound *SmC** (*uSmC**) phase with respect to the *SmC** one.

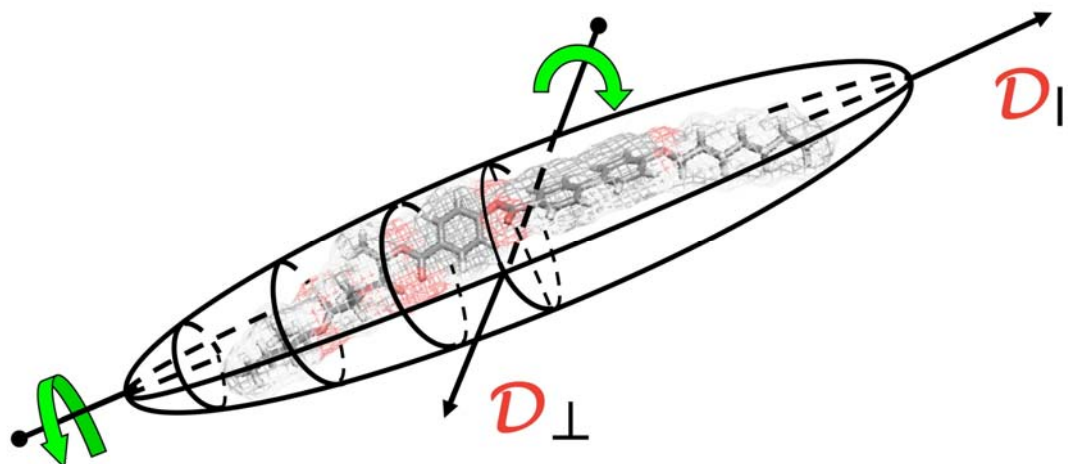

Sugar-based 1,2-O-(1-ethylpropylidene)- α -D-glucofuranose organogelator and its gels

Michał Bielejewski, Narcyz Piślewski, Jadwiga Tritt-Goc

Institute of Molecular Physics, Polish Academy of Sciences, ul. M. Smoluchowskiego 17, 60-179 Poznań, Poland

The subject of our study, 1,2-O-(1-ethylpropylidene)- α -D-glucofuranose, is a new exciting representative of low-molecular-weight organogelators that has the ability to gel various organic solvents, at very low concentrations (0.05 to 4% w/w). The gels are thermoreversible, physical gels which consist of a three dimensional fibrillar network. The network is composed of the gelator molecules that self-assemble via noncovalent interactions and of a large amount of solvent molecules trapped in the gel network. Supramolecular organogels have attracted much interest because of their unique properties and potential applications as new soft materials (1).

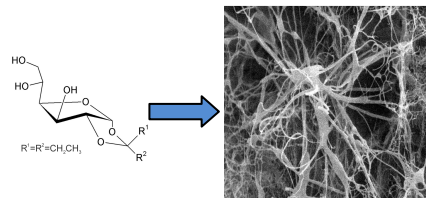

Figure 1. A schematic structure of studied gelator and SEM image of its 3 wt % benzene gel.

The aim of our study was to determine the solvent effect on the gel formation by 1,2-O-(1-ethylpropylidene)- α -D-glucofuranose, in particular the occurrence of the interaction between the solvent molecules and the aggregates of the gelator molecules. This, despite many studies, remains an open question. Additionally, the molecular dynamics of the studied gelator in the solid state was investigated.

The method used: ^1H NMR relaxation measurements in the function of temperature and frequency; FT IR spectroscopy, air-bath method for T_{GS} measurements.

Results: The dynamics of gelator molecules in solid state are governed by the reorientation of methyl groups which are in three inequivalent sites in the crystal. The driving forces for gel assembly are the H-bonding interactions. The thermal stability of the gels depends on the polarity of the solvents (2,3). The observed low-frequency spin-lattice relaxation behavior of toluene in the network gel can be explained by the interaction of the solvent molecules with the surface of the gelator molecules forming the fibrillar network in the gel. The T_1 dispersion arises because toluene molecules execute Levy walks on the surface network, mediated by the liquid bulk.

Acknowledgments: M.Bielejewski thanks Prof. E. Roessler from University in Bayreuth for his hospitality, fruitful discussion and possibility to use FFC Spectrometer.

This work has been supported by funds for sciences in years 2007-2009 as research project N N202 1441 33.

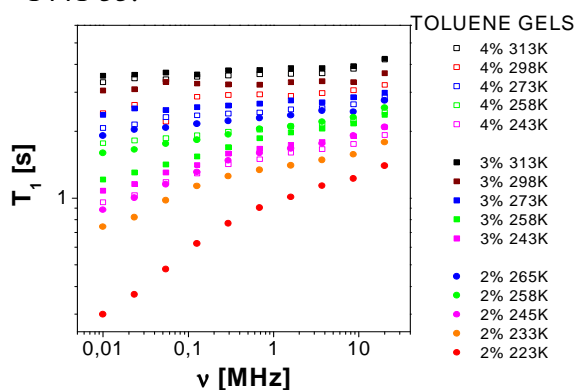

Figure 2. Frequency dependence of the proton spin-lattice relaxation time of toluene in 1,2-O-(1-ethylpropylidene)- α -D-glucofuranose gel.

Conclusion: The solvent molecules interact with the 1,2-O-(1-ethylpropylidene)- α -D-glucofuranose aggregates in its gels with benzene, toluene, nitrobenzene and chlorobenzene.

References:

1. P. Terech, R.G. Weiss, *Chem. Rev.*, 97, 3133-3159, 1997
2. J. Tritt-Goc, M. Bielejewski, R. Luboradzki, A. Łapiński, *Langmuir* 24, 534-540, 2008
3. M. Bielejewski, A. Łapiński, J. Kaszyńska, R. Luboradzki, J. Tritt-Goc, *Tetrahedron Letters* 49, 685- 6689, 2008

Protein Hydration Dynamics unveiled by temperature dependent NMR measurements

Johan Qvist, Carlos Mattea[§], Kristoffer Modig & Bertil Halle

Department of Biophysical Chemistry, Lund University

*We have measured, with the aid of NMR, the water rotational correlation time over a wide range of temperatures extending down to 238 K, both in bulk water as well as in the hydration layer of four organic molecules (two osmolytes, TMU and TMAO, and two model peptides, NAGMA and NALMA) and five different proteins (bovine beta-lactoglobulin, equine apo-myoglobin, bovine pancreatic trypsin inhibitor, ubiquitin and antifreeze protein from the beetle *Tenebrio Molitor* (TmAFP)). By comparing our samples with the results from bulk water we have been able to characterize the dynamical perturbation in the hydration layer of these biological systems.*

Our findings suggest striking similarities as well as profound differences between the different systems. We find that for all investigated systems the dynamics in the hydration layer is much more Arrhenius like than in bulk water where all dynamical properties seemingly diverge at a temperature slightly below the homogeneous nucleation temperature (thus out of range for any experimental characterization). This imply that the water molecules will actually rotate faster in the hydration layer than in bulk at sufficiently low temperatures. Furthermore the vast majority of water molecules in the hydration layer behave like the water hydrating the smaller organic molecules, the only principal difference being a small fraction of more perturbed sites at protein surfaces associated with deeper crevices etc.

Interestingly enough the results for the antifreeze protein, TmAFP, differed qualitatively and quantitatively from the other proteins. Whereas we were able to describe the data from all other proteins with a very similar mean activation energy and a short ranged perturbation in our whole temperature range, the TmAFP sample showed signatures of a lower activation energy than the other proteins and an increased perturbation range at reduced temperature. This is striking as the perturbation range have previously been shown to be short ranged at room temperature, mainly confined to the first monolayer of water molecules. However our results show, model independently, that the range must be substantially longer for TmAFP at temperatures below about -27 °C.

[§]Present address: Institute of Physics, Technical University of Ilmenau, Ilmenau, Germany.

Nuclear relaxivity and Magnetisation measurements of Fe₃O₄ nanoparticles as Superparamagnetic contrast agents for MRI

T. Kalaivani,^{d,e} Lenaic Lartigue,^{ac} Khalid Oumzil,^b Yannick Guari,^{a*} Joulia Larionova,^a Christian Guérin^a, Jean-Louis Montero,^b Veronique Barragan-Montero,^b Claudio Sangregorio,^{c*} Andrea Caneschi,^c Claudia Innocenti,^c P. Arosio,^d Alessandro Lascialfari^{def}

^aInstitut Charles Gerhardt Montpellier, UMR 5253 CNRS-UM2, Chimie Moléculaire et Organisation du Solide, Université Montpellier II, Place E. Bataillon, 34095 Montpellier cedex 5, France.

^bInstitut des Biomolécules Max Mousseron, UMR 5247, CNRS-UM1-UM2, Bâtiment de Recherche Max Mousseron, Ecole Nationale Supérieure de Chimie de Montpellier, 8 rue de l'Ecole Normale, 34296 Montpellier Cedex, France

^cINSTM Research Unit-Dipartimento di Chimica, Università di Firenze, via della Lastruccia 3, 50019 Sesto F.no Firenze, Italy.

^dDipartimento Scienze Molecolari Applicate Al Biosistemi (DISMAB), Università degli Studi di Milano, I-20134 Milano, Italy.

^eCNR-INFM-S3 NRC, I-41100 Modena, Italy.

^fDipartimento di Fisica "A. Volta" and CNR-INFM, Università degli studi di Pavia, Via Bassi 6, I-27100 Pavia, Italy.

We report the nuclear relaxivity and magnetisation measurements of water soluble, biocompatible rhamnose-coated Fe₃O₄ nanoparticles as potential superparamagnetic contrast agents for MRI. The choice of the coating was motivated by "ex vivo" study on human skin that confirmed the specificity of rhamnose sugar as specific marker of the skin or the cornea layer. Fe₃O₄ nanoparticles have been obtained by the organic phase covalent anchorage of rhamnose on the nanoparticles surface via a phosphate linker. TEM measurements performed on the as-synthesised nanoparticles, confirmed the spherical, non-aggregated, uniform nanoparticles of size 4.0 ± 0.7 nm. The Zero-field cooled/Field cooled measurements and susceptibility measurements confirmed the superparamagnetic nature of the Fe₃O₄ nanoparticles. ¹H NMR relaxometry characterization has been performed in the frequency range 10 KHz ≤ ν ≤ 65 MHz, at room and physiological temperature. The efficiency of the MRI contrast agents has been determined by measuring the nuclear relaxivities r_{1,2}, that resulted comparable to Endorem® (a commercial contrast agent) in the whole frequency range. Hence our sample paves a promising way towards a new family of superparamagnetic contrast agents of second generation, where the saccharides represent the bound vectors devoted to target specific skin cells.

Study of new mesoporous silica materials by ^1H R_1 full dispersion curves (0-400 MHz)

Emilie Steiner⁽¹⁾, Sabine Bouguet-Bonnet⁽¹⁾, Daniel Canet⁽¹⁾

⁽¹⁾Cristallographie, Résonance Magnétique et Modélisation, Méthodologie RMN, Nancy-Université, CNRS, Faculté des Sciences et Techniques, B.P. 239, 54506 Vandœuvre-lès-Nancy Cedex, France.

Relaxometry was applied to a new class of mesoporous materials prepared via a Cooperative Templating type Mechanism (J.L. Blin and al., *Langmuir* 2004, 20, 491-498). These materials, with a particular structure, possess interesting potential applications (catalysis, separation processes...).

This study rests on the evolution, as a function of B_0 , of the longitudinal relaxation rate of water imbedded in these materials. Besides conventional relaxometry (experiments performed in the range 0-10 MHz with a *Stelar Smartracer*), the 10-90 MHz range was investigated by means of a homemade NQR/NMR spectrometer equipped with a variable field electromagnet. Moreover, conventional spectrometers provided measurements at 200, 300 and 400 MHz.

The full dispersion curve was analyzed by assuming that it results from the superposition of several Lorentzian functions, each of them being associated with a specific correlation time and a specific amplitude. A tentative interpretation is proposed.

Investigation of a New Class of Gd-Based Nanoparticles for Magnetic Resonance Imaging

Purificaci3n S3nchez¹, Elsa Valero¹, Natividad G3lvez¹, Jos3 M. Dominguez-Vera¹, Massimo Marinone^{2,4}, Alessandro Lascialfari^{2,3,4}, Giulio Poletti², Maurizio Corti^{3,4}, Houshang Amiri^{2,3}

¹ Departamento de Quimica Inorg3nica, Facultad de Ciencias, Universidad de Granda, 18071, Spain

² DISMAB, Universit3 degli studi di Milano, Via Trentacoste 2, 20134, Milano, Italy

³ Dipartimento di Fisica "A. Volta", Universit3 degli studi di Pavia, and CNR-INFM, Via Bassi 6, 27100, Pavia, Italy

⁴ S3-CNR-INFM, Via Campi 213, 41100 Modena, Italy

We have synthesized water-soluble gadolinium oxide nanoparticles, which show potential as MRI contrast agent (CA). The 8 nm-sized empty cavity of apoferritin has been used as a chemically and spatially confined environment for building biomimetic (metal oxide or oxyhydroxide) or non-biomimetic (zero-valent metal, Prussian-blue complexes, etc.) nanoparticles, which have an average size of 5nm. Under physiological conditions, only 5% loss of Gd was detected after 7 days, indicating that the apoferritin capsid acts as a Gd store, avoiding metal delivery and consequent toxicity.

The efficiency of the Gd-apoferritin sample in contrasting the MRI images has been investigated. To this aim, we estimated the longitudinal and transverse nuclear ¹H relaxivities, r_1 and r_2 , as a function of frequency at room and physiological temperature. The r_1 and r_2 relaxivities are much higher than the ones of commercial Gd(III)-complexes (10÷25 and 70 times, respectively). Moreover, by frequency increasing, at around 30 MHz the r_2/r_1 ratio changes from values typical of negative CA to values pertaining to positive CA, suggesting that our samples are a promising field-tunable class of contrast agents.

Hydrogen dynamics in partially quasicrystalline $Zr_{69.5}Cu_{12}Ni_{11}Al_{7.5}$: A fast field cycling nuclear magnetic relaxometry study

Anton Gradišek^a, Janez Dolinšek^a and Tomaž Apih^a

^aJožef Stefan Institute, Jamova 29, 1000 Ljubljana, Slovenia

Temperature and magnetic-field dependence of hydrogen nuclear magnetic resonance (NMR) spin-lattice relaxation rate were measured using fast field cycling relaxometer in hydrogenated partially quasicrystalline $Zr_{69.5}Cu_{12}Ni_{11}Al_{7.5}$ metallic alloy with hydrogen-to-metal (H/M) ratio 0.65. The spin-lattice relaxation motion is well described as a thermally activated process with Gaussian distributed activation energies. The mean activation energy $E_a = 367$ meV is in close agreement with the value obtained previously for direct measurement of hydrogen diffusion [1], suggesting that long range diffusion and not the local hopping is the main mechanism responsible for the hydrogen spin-lattice relaxation. From spin lattice relaxation and diffusion measurements, hydrogen mean average jump length can be estimated.

References

[1] T. Apih et al, *Phys. Rev. B* 68, 212202 (2003)

The use of Fast Field-Cycling technique with Magnetization Transfer Contrast MRI

C-H. Choi, G.R. Davies and D.J. Lurie

Aberdeen Biomedical Imaging Centre, University of Aberdeen, Foresterhill, AB25 2ZD, UK

Introduction: It is well known that the use of fast field-cycling (FFC) with MRI affords access to new contrast mechanisms [1]. In this work, we have applied the FFC technique to magnetisation transfer contrast (MTC) MRI. An off-resonance irradiation pulse (MT pulse) is typically employed for MTC experiments to saturate the bound protons, without directly affecting the free protons [2]. This is, conventionally, achieved with applying a constant specified RF magnetic field strength (B_1) over a range of RF offset frequencies (A and B in Fig. 1). However, B_1 is apt to decrease considerably with increasing offset frequency, particularly at low field, because of the limited bandwidth of the RF transmit system, in turn requiring B_1 calibration (Fig. 2). The range of offset frequencies available may be also limited. Here, we investigate an alternative off-resonance method, using FFC, which permits one to counter these complications. The MT pulse is applied at a constant frequency, but the external magnetic field (B_0) is altered by FFC in order to achieve off-resonance irradiation (C and D in Fig. 1). This method provides the same off-resonance effect as the conventional method, but without the complications.

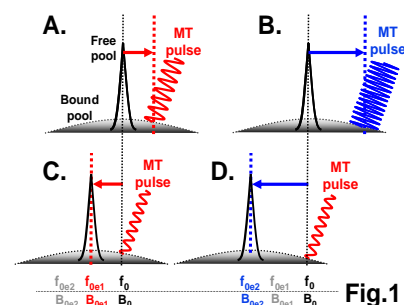

Fig.1

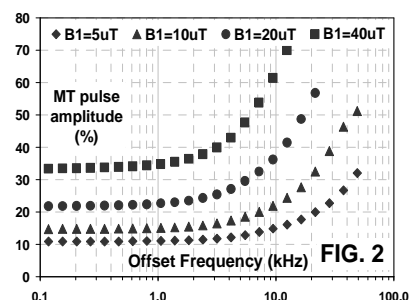

FIG. 2

Methods: Experiments were carried out using a whole-body field-cycling MRI scanner [3] (detection at 58.7 mT) with 1%, 2%, and 4% agarose gels (samples A, B and C in Fig. 4). In order to achieve an effective 11 kHz off-resonance irradiation, for example, the MT pulse was irradiated at 2.499 MHz but the applied magnetic field was set to 58.44 mT (equivalent to 2.488 MHz). The magnetic field was switched between the levels within 5 ms.

Results and discussion: The Z-spectra [4] and the MT ratios ($1-M_s/M_0$) obtained from both methods were compared. Fig. 3 shows the Z-spectra of a 2% agarose gel, where the difference between the results is less than 3%. Fig. 4 illustrates the images acquired by means of the FFC method (top row) and the conventional RF method (bottom row), with MT irradiation (right column) and without (left column). Due to the absence of bound protons in the control sample, the MT effect (or MT ratio) is almost zero while MT effects increase with increasing concentration of the agarose. This result also shows excellent agreement between the measurements obtained by the two different methods.

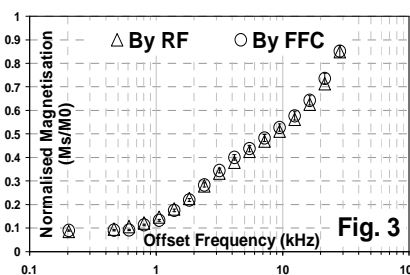

Fig. 3

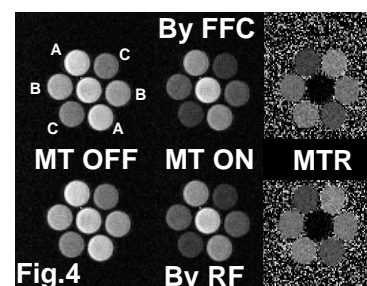

Fig.4

Conclusions: We have demonstrated the applicability of the new off-resonance technique for MTC MRI with the important progress that re-calibration of B_1 is not required. Experimental results obtained by the FFC technique agree well with those obtained by the RF off-resonance method.

References: [1] Lurie DJ, Proc. 7th ISMRM, p. 653 (1999). [2] Wolff SD, Balaban RS, MRM, 10, p. 135-144 (1989). [3] Lurie DJ et al., Phys. Med. Biol. 43, p. 1877-1886 (1998). [4] Grad J, Bryant RG, JMR 90, p. 1-8 (1990).

Localised *In Vivo* Relaxometry with Fast Field-Cycling

K. J. Pine, G. R. Davies, D. J. Lurie

Aberdeen Biomedical Imaging Centre, University of Aberdeen, Scotland.

<http://www.ffc-mri.org>

In biomedical applications, knowledge of the NMR relaxometric behaviour of tissue is widely used to distinguish diseased from healthy states. Fast field-cycling (FFC) promises access to new sorts of endogenous information. The familiar dispersion plot of T_1 (or R_1) versus evolution field B_0^E can be used to quantify protein [1], and to inform the selection of field strengths and pulse sequence parameters for field-cycled MR imaging. In this work, we have compared two approaches to producing dispersion plots for localised volumes.

One method of acquiring dispersion plots involves conventional spin-echo two-dimensional Fourier transform imaging preceded by periods with the main magnetic field switched to the evolution field of interest [2]. The sequence is repeated at several evolution time steps before being repeated at each field of interest. The dispersion plot can be determined after manual selection of a region of interest (ROI) on the image and fitting mean signal intensity to a monoexponential approach to equilibrium. While we have an implementation of this method for comparison purposes, it suffers from clinically infeasible scan times (approximately 2 hours based on 4 minutes imaging time per field point and 32 field points) and partial volume errors. Data are acquired for the entire field of view.

We have investigated an alternative approach, which borrows methods from point resolved spectroscopy (PRESS) [3] and combines them in a pulse sequence with field-cycled inversion-recovery to produce dispersion plots of volumes of interest (VOIs) selected on pilot MR images. An adiabatic fast passage (AFP) inversion is applied, followed by field-cycling for an evolution period of the order of T_1 . A series of RF pulses (90-180-180) is then applied in the presence of orthogonal gradients. The sequence is repeated without inversion, and the two resultant spin echo signals used to estimate T_1 . The entire sequence is repeated at each evolution field step. The typical acquisition time for a localised T_1 dispersion plot (32 field points) comprises 2 minutes for the pilot images, plus 4 minutes for the dispersion plot.

Implemented on our home-built 59 mT whole-body field-cycling MRI system [4], the image-selected volume-localised method was sufficiently sensitive to observe quadrupole dips on T_1 dispersion plots in regions of human thigh. The technique offers the possibility of acquiring localised NMR relaxometry data from human subjects in clinically viable scan times.

References

- [1] Davies, G.R. *et al.*, *4th Conference on Field-Cycling NMR Relaxometry*, 2005.
- [2] Carlson, J.W. *et al.*, *Radiology*, 184:635, 1992.
- [3] Bottomley, P.A., *Ann N Y Acad Sci*, 508:333, 1987.
- [4] Lurie, D.J. *et al.*, *Phys Med Biol*, 43:1877, 1998.

Towards a single resistive magnet 0.5 T Fast Field Cycled Magnetic Resonance Imaging System

G.R. Davies, K.J. Pine and D.J. Lurie

Aberdeen Biomedical Imaging Centre, University of Aberdeen, Scotland.

<http://www.ffc-mri.org>

Motivation: The accessibility of novel image contrast mechanisms, through the use of field cycling, has been demonstrated by a number of groups [1,2]. We have previously employed a system in which the polarizing and detection magnetic fields were provided by a 0.45 T superconducting magnet whilst the evolution field, applied between the periods of polarisation and detection, was generated by a co-axial self shielded resistive field-offset magnet [3,4]. However it was felt that using a solitary resistive magnet would have a number of advantages: (a) allowing operator control of all the magnetic fields; (b) removing post field-switching field instabilities, caused by eddy currents induced in low temperature radiation shields; (c) no longer requiring cryogenics; and (d) allowing a more compact geometry with improved accessibility.

Methods: Following decommissioning of the primary (detection field) superconducting magnet, we have used our existing 0.45 T resistive field-offset magnet as a test-bed for single-magnet FFC-MRI. In a preliminary study we investigated the effects of the magnet temperature on the field stability of the magnet. The system was programmed to acquire a series of 128 free induction decays after polarising the spins at 0.45 T for 500 ms with 500 ms at zero field between each acquisition. The temperature of the magnet's output cooling water was measured with a PT100 resistive thermometer. The output temperature of the Neslab HX2000 chiller, which supplied the cooling water, was also observed. Once it was established that some degree of thermal, and thus magnetic, equilibrium could be established spin echo (SE) imaging of an axial slice through a sample bottle containing CuSO_4 solution was attempted.

Results:

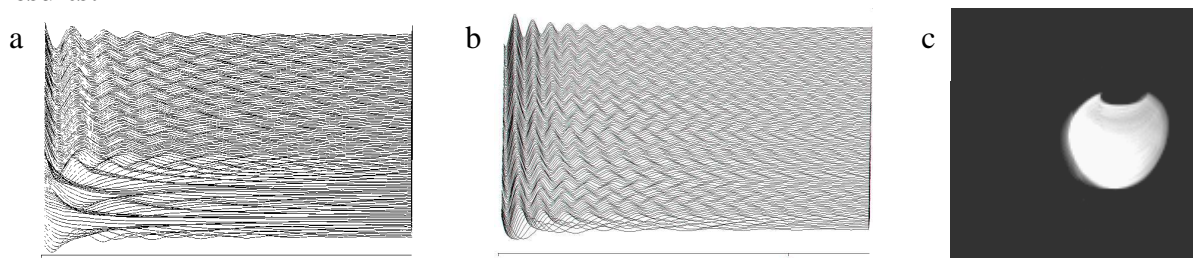

Figure: (a) and (b) show stack plots of 128 FIDs, with first acquisition at front (foot). Plot (a) shows the effect of starting the acquisitions with the magnet at 21 C. A significant change in the tuning of each successive acquisition can be seen as the temperature rose to 35 C. Plot (b) shows the comparative stability when the system was brought to 35 C before the acquisitions were started. There is still some degree of instability which can be traced to the hysteresis in the temperature of the water from the chiller, which hunted between 18 C and 25 C. On the right is a 128 by 128 pixel SE image of a 10 mm slice through a 60 ml bottle of 2.5 mM CuSO_4 solution acquired in about 2.5 minutes. A dummy acquisition had been used to raise the magnet temperature to 35 C before the image was acquired.

Conclusions: Field stability was sufficient in order to collect an image, which was remarkably free from ghosting artefacts. We are in the process of constructing a new single-magnet 0.5 T FFC-MRI system with a dedicated magnet.

References:

- [1] S. E. Ungersma *et al.* *Magn.Reson.Med.* **55** (2006) 1362.
- [2] J.K. Alford *et al.* *Concepts. Magn. Reson.* **35B** (2009) 1.
- [3] D.J Lurie *et al.* *Magn.Reson.Imaging.* **23** (2005) 175.
- [4] G. R. Davies and D.J.Lurie. *Proc. Int. Soc. Mag. Reson. Med.* **13** (2005) 2187.

Contrast Optimisation using Fast Field-Cycling MRI

D. O Hogain¹, G. R. Davies¹, D. J. Lurie¹ and S. Baroni²

¹Aberdeen Biomedical Imaging Centre, University of Aberdeen, Scotland

²Department of Chemistry 'IFM', University of Torino, Italy

<http://www.ffc-mri.org>

Introduction: Fast Field-Cycling (FFC) techniques have been combined with MRI to allow acquisition of T_1 dispersion curves of a sample, combined with the ability to image at a range of magnetic field strengths during an MRI scan [1]. Contrast agent relaxivity is strongly dependent on B_0 , thus it is possible, using FFC, to select the field which maximises contrast enhancement in a T_1 weighted image. In this experiment the relaxivity properties of contrast agents in tissue-mimicking bovine serum albumin (BSA) were obtained using FFC relaxometry. FFC-MRI was then used to obtain images at fields showing maximum contrast between pure BSA and BSA containing different contrast agents. Two contrast agents 'Hemalbumin' and 'USPIO Sinerem' were investigated for possible use with FFC-MRI.

Methods: T_1 dispersion curves were obtained using both a commercial relaxometer (Stelar s.r.l., Italy) [2] and a home built FFC-MRI system. BSA was used as a tissue substitute [3], into which selected contrast agents were added. The samples chosen are labelled below; 1: Hemalbumin 0.1mM, 2: CuSO₄ 0.5mM, 3: MnCl₂ 0.1mM, 4: Hemalbumin 0.5mM, 5: CuSO₄ 1mM, and 6: USPIO Sinerem 0.12mM. These samples were chosen based on their dispersion properties in water. Dispersion curve information was then used to determine the magnetic field which would allow maximum signal enhancement caused by the contrast agents in BSA [4]. Imaging experiments were carried out using a home-built FFC-MRI system which allowed images to be produced at any field between 1 and 59 mT.

Results: Figure 1 shows the R_1 dispersion curves obtained from different contrast agents in BSA. This information was used to select the magnetic field which would result in maximum contrast enhancement between any two samples. Figure 2 shows images of the solutions at different field strengths: 59 mT on the left, and 1 mT on the right.

Conclusions: The solutions used in this study were specifically chosen due to their high dispersion between 0 and 59 mT, thus showing wide changes in contrast when switching from low fields to high fields. This shows that FFC-MRI can be used to manipulate image contrast, potentially enabling agents to be "switched on and off" during a single scan. The properties of tissues though different to BSA have similar dispersion characteristics and are amenable to contrast optimisation via field cycling. The crucial advantage, and the power of FFC-MRI is that the evolution magnetic field can be set to any chosen value (within the limits of the instrument), while signal detection remains at a fixed magnetic field. This work shows that FFC-MRI, in combination with T_1 dispersion measurements, allows the optimisation of contrast as a function of evolution magnetic field strength.

References:

1. Lurie, D. J. et al., *Phys Med Biol*, 43, 1877:1886, 1998.
2. Koenig and Brown, *MRM*, 30, 685:695, 1993
3. Ferrante, G. and Sykora, S., *Adv Inorg Chem*, 407:470, 2004
4. Carlson, J. W. et al, *Radiology*, 184:635, 1992.

6th conference on Field Cycling NMR relaxometry - Turin, Italy 4-6 June 2009

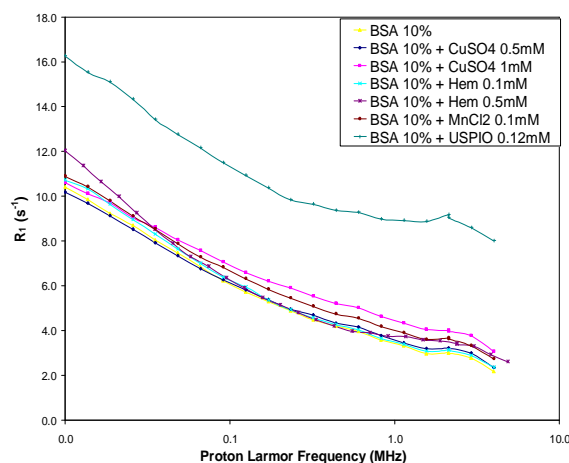

Figure 1: R_1 dispersion curves of contrast agents in BSA 10%

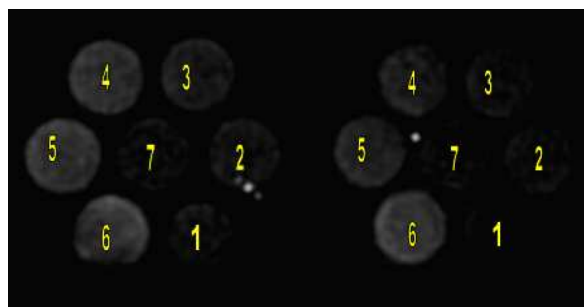

Figure 2: Images of phantom at 59 mT (left) and 1 mT (right). Numbers indicate the sample type, as listed under Methods.

Detection of fibrin by Fast Field-Cycling magnetic resonance techniques

Saadiya Ismail, Lionel Broche, Nuala A. Booth and David J. Lurie
 Aberdeen Biomedical Imaging Centre, University of Aberdeen, Scotland, UK
<http://www.ffc-mri.org>

Aggregated proteins are central to several diseases such as thrombosis, Huntington's disease, Alzheimer's disease or Parkinson's disease. An early detection of protein aggregate formation in the human body could therefore be of great interest for the diagnosis of such diseases. The aim of our research is to investigate the possibility of detecting protein aggregation by using fast field-cycling (FFC) nuclear magnetic resonance relaxometry and FFC-MRI.

Here we examine the feasibility of detecting one particular type of protein aggregation: the fibrin clot, which is the protein network that stabilises a thrombus. This choice was motivated by the wide literature available about fibrin that provides much detail about the model system of the formation of fibrin clots [1]. Fibrin clot formation is a key process in haemostasis, which restricts blood loss from wounds, and of thrombosis, which results from increased fibrin stability in the circulation, leading to a blockage of blood vessels. Fibrin, like proteins in general, is rich in ^{14}N and its mobility is reduced due to the web-like structure of a clot so it is a potential source of ^{14}N quadrupole dips in a ^1H T_1 dispersion plot [2]; a sample that presents quadrupole dispersion plot therefore indicates the formation of fibrin clots.

Samples of clotted fibrinogen were prepared through the cleavage of fibrinogen by an enzyme, thrombin, and were analysed by NMR relaxometry using a STELAR SMARtracer FFC relaxometer. This provided a measure of the T_1 dispersion curve between 1.5 and 3.5 MHz, which included the region of the two main quadrupole dips of ^{14}N (at 49 mT and 65 mT – i.e. 2.1 MHz and 2.8 MHz), using an inversion recovery pulse sequence. The determination of the relationship between fibrin concentration and dip amplitude was investigated by preparing samples with differing concentrations of fibrinogen (between 0.4 mg/ml and 20 mg/ml) and monitoring the corresponding quadrupole dip amplitude.

Preliminary results suggest that FFC relaxometry should be able to provide useful information concerning thrombus production. This may lead to novel diagnostic imaging techniques using FFC magnetic resonance imaging.

References:

- [1] Blombäck, B., Carlsson, K., Fatah, K., Hessel, B. & Procyk, R. 1994, Fibrin in human plasma: Gel architectures governed by rate and nature of fibrinogen activation, *Thrombosis Research*, **75**, 521-538.
- [2] Winter F. and Kimmich R, 1982, NMR field-cycling relaxation spectroscopy of bovine serum albumin, muscle tissue, micrococcus luteus and yeast. $^{14}\text{N}^1\text{H}$ -quadrupole dips, *Biochim. Biophys. Acta* **719**, 292-298.

Low field relaxation studies of polar and nonpolar molecules in partially filled micrometric pores

Ruben Nechifor, Codruta Badea, Ioan Ardelean

Technical University of Cluj Napoca, Physics Department, 400020 Cluj-Napoca, Romania

E-mail: ioan.ardelean@phys.utcluj.ro

The behavior of fluids in systems with restricted geometry is known to be very different from that in bulk. The physical properties of molecules adsorbed on the surface or confined in small pores may substantially differ from the properties of their bulk materials. Owing to its completely non-invasive character, nuclear magnetic resonance (NMR) is widely used to investigate the dynamics of molecules confined in porous media. NMR measurements of relaxation times and diffusion coefficients render quantitative data on the dynamics of confined molecules and the restrictions the confinement imposes on their translational and rotational mobility.

Provided that some conditions are fulfilled, diffusion measurements of liquids partially filling porous media have indicated an enhanced self-diffusion coefficient relative to the bulk phase [1-3]. The reason for such observations is the molecular exchange process between two phases: liquid and saturated vapor. Translational displacements in the vapor phase being much faster than in the liquid phase contribute to the enhancement of the effective diffusion coefficient. The contribution of the vapor phase to molecular diffusion in porous glasses with nanometer and micrometer pores partially filled with cyclohexane (non-polar) or water (polar) was investigated for a wide range of diffusion times (100 μ s-1 s) using NMR diffusometry techniques [1-3]. It was concluded that the vapor phase contribution to the effective diffusivity is particularly efficient on a diffusion time scale corresponding to root mean squared displacements of the order of pores dimension [4].

In present contribution we are investigating the vapor phase effects on relaxation times distribution in a porous glass partially saturated with polar (water, acetone, ethanol) and nonpolar (cyclohexane, hexane, tetradecane) molecules. The porous sample is a silica glass (Vitrapor#5) purchased from ROBU Glasfilter-Geräte GmbH, Germany. The nominal mean pore size is $d=1 \mu\text{m}$ ($\pm 0.6 \mu\text{m}$) as indicated by the manufacturer. All relaxation experiments were performed on a Bruker MINISPEC MQ20 spectrometer operating at a proton resonance frequency of 20 MHz. The data were recorded at 20°C using the standard CPMG technique. Relaxation times distributions were obtained from echoes decay using a regularized numerical Laplace inversion algorithm (CONTIN) [4]. The experimental results have been compared with a two phase exchange model providing us information on liquid morphology under partially saturated conditions. The contribution of the vapor phase to the observed relaxivity is also discussed.

Financial support by the Romanian CNCSIS and European Social Fund (project POSDRU/6/1.5/S/5) is gratefully acknowledged.

References:

- [1]. F.D'Orazio, S.Bhattacharja, P.Halperin, and R.Gerhardt, *Phys.Rev.Lett.* **63**, 43(1989).
- [2] R.Valiullin, S. Naumov, P. Galvosas, J. Kärger, H.J. Woo, F Porcheron, P.A. Monson, *Nature* **443**, 965 (2006).
- [3]G. Farrher, I. Ardelean and R. Kimmich, *Appl. Magn. Reson.* **34**, 85-99(2008).
- [4]. S. W. Provencher, *Comp. Phys. Comm.*, **27**, 229 (1982).

Tetrazole Group as ^{14}N NQR Probe

Janez Pirnat, Janko Lužnik, Tomaž Apih, Anton Gradišek*, and Zvonko Trontelj
Institute of Mathematics, Physics and Mechanics, Ljubljana,
and *Institute Jožef Stefan, Ljubljana, Slovenia*

Tetrazole ring CH_2N_4 (abbrev. TZ) can act as a starting point for new developing family of explosives with outstanding properties.ⁱ This pentagonal structure appears also as a functional group in a number of new pharmaceutical products and in many synthetic pathways as a precursor of various heterocycles containing nitrogen. Because of several inequivalent ^{14}N atoms TZ group is applicable as a »natural« multi-point NQR probe.

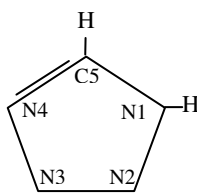

Fig.1. 1H-tetrazole

^{14}N NQR frequencies and corresponding spin-lattice relaxation have been measured in 5-aminotetrazole and in 5-aminotetrazole monohydrate at different temperatures between 77K and 300K. Five NQR triplets ν_+ , ν_- and ν_0 have been found for five inequivalent nitrogen atoms in each compound between 0.7MHz and 4MHz. Long Carr-Purcell based multipulse sequence (~100 pulses or more) was used to quickly accumulate pure quadrupole echo records subjected afterwards to the FFT analysis. The assignment of the frequencies to atomic positions was done and the results are analysed in view of the molecular chemical bonds and possible H-bonds in the crystal structures.

The above signals, though relatively easy detectable through pure NQR, proved surprisingly difficult to be detected via routine FFC procedure of quadrupole dips, due to slow, unsuitable proton and ^{14}N relaxations. Usually FFC relaxometry is one of the starting methods for quick preliminary location of frequency regions of NQR activity. Investigations of adapted FFC methods for optimum indirect detection of ^{14}N NQR in tetrazole group, included in larger molecules, are in progress to facilitate the subsequent accurate pure NQR studies.

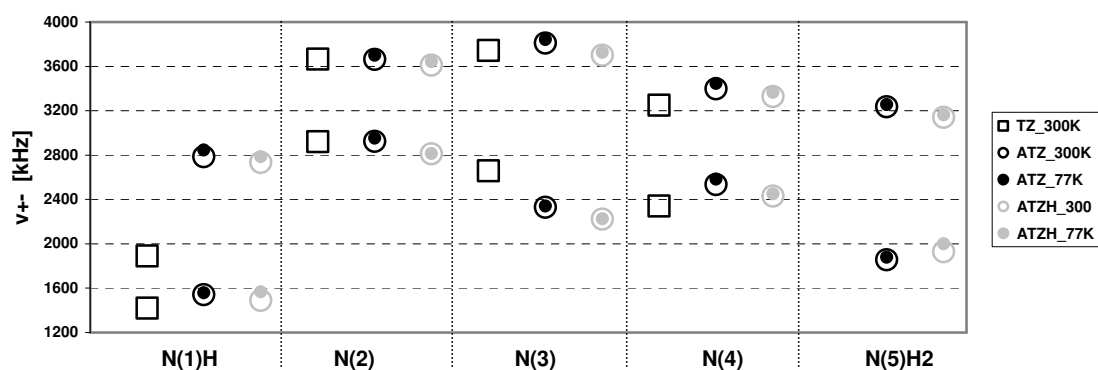

Fig.2. Assignment and comparison of the corresponding ν_+ and ν_- ^{14}N NQR pairs, suitably combined from 1H-tetrazole (TZ, published dataⁱⁱ), 5-aminotetrazole (ATZ) and 5-aminotetrazole monohydrate (ATZH) into respective segments N(1)H, N(2), N(3), N(4), N(5)H₂.

ⁱ Klapötke, High Energy Density Materials in: Structure & Bonding, (Springer Berlin / Heidelberg, 2007) Vol.125/2007, pp 85-121.

ⁱⁱ H.Palmer, D.Stephenson and J.A.S.Smith, Chem.Phys. **97**, 103-111 (1985).

Magnetic field conditioning system for field-cycling NMR

Guillermo O. Forte, Hector Segnorile, German Farrher, Martín Herrera, Josefina Perlo and Esteban Anoardo.

*Larte – Famaf. Universidad Nacional de Córdoba and IFFAMAF (CONICET).
Córdoba – Argentina.*

In some cases field-cycling experiments requires both a good definition of the Larmor frequency within the ULF regime (ultra low frequency) and high magnetic field homogeneity during signal acquisition. In addition, sharp pronounced transients when switching the magnetic field may produce undesirable effects in the experiments. Depending on the available hardware, such limitations can be overcome more or less easily with specific solutions. In any case, the availability of a specific tool for the analysis and diagnosis of these limitations or any other due to system failures is appreciated. We will discuss a technological integrated universal platform that can be adapted to any magnet-geometry. The system compensates external static and time-dependent mean fields and first order gradients, correct magnetic field inhomogeneity and allows to scan and analyze the time and spatial dependence of the magnetic field.

Noticed Discrepancies when Evaluating Experimental Data¹⁻⁸ against Theoretical Model⁹ on the Characterization of Superparamagnetic Particles as Contrast Agents in MRI

Nazario Felix, J. Javier Serrano, Roberto Molina, Francisco del Pozo
Grupo de Bioingeniería y Telemedicina – ETSI de Telecomunicación, UPM.
Centro de Investigación Biomédica en Red: Bioingeniería, Biomateriales y
Nanomedicina, Spain.

Abstract

Contrast Agents in MRI enhances the differences between tissues with similar properties by locally modifying the nuclear relaxation rates of water protons. Superparamagnetic particles consist of an iron oxide core coated with macromolecular materials that significantly reduce the transverse relaxation rate caused by the local field created by its large magnetic moment. The efficiency of a Contrast Agent is determined by its longitudinal and transversal relaxivities, defined as the relaxation rate per mol of colloid. Some theories have been formulated to describe physical phenomena associated with the proton relaxation by superparamagnetic particles, which have been probed with the Nuclear Magnetic Relaxation Dispersion profiles obtained with the technique of fast field cycling. These theories are important not only for describing these phenomena but also for the design and fabrication of the contrast agents, along with their ability to predict the behavior of certain types of particles prior to their manufacture. In this work an evaluation of some experimental data against a theoretical model is done, some discrepancies have been found and an effort is made trying to explain them, based on the theory of proton relaxation developed by R.N. Muller et.al.⁹ While longitudinal relaxivity largely depends on the magnetization of the particles and the size of the magnetic core, transversal relaxivity reflects the ability of the contrast agent to produce local magnetic inhomogeneities. Some of these inconsistencies can be explained by a low field dispersion caused by the anisotropy of the crystal, or by the aggregation of the particles in solution. In a future work an attempt will be made to confirm these assumptions over the NMRD profiles obtained in our laboratory. As there are certain kind of knowledge on the molecular dynamics of the superparamagnetic particles enhancement mechanisms, not everything has been told and a complete understanding and characterization of particles on a biological environment are needed to take advantage on the enormous potential of these applications.

References

1. Corti M, Lascialfari A, Micotti E, Castellano A, Donativi M, Quarta A, Cozzoli PD, Manna L, Pellegrino T, Sangregorio C. Magnetic properties of novel superparamagnetic MRI contrast agents based on colloidal nanocrystals. *J Magn Magn Mater* 2008.
2. Corti M, Lascialfari A, Marinone M, Masotti A, Micotti E, Orsini F, Ortaggi G, Poletti G, Innocenti C, Sangregorio C. Magnetic and relaxometric properties of polyethylenimine-coated superparamagnetic MRI contrast agents. *J Magn Magn Mater* 2008.
3. Yan G, Robinson L, Hogg P. Magnetic resonance imaging contrast agents: Overview and perspectives. *Radiography* 2007 12;13(Supplement 1):e5-e19.
4. Corot C, Robert P, Idée J, Port M. Recent advances in iron oxide nanocrystal technology for medical imaging. *Advanced Drug Delivery Reviews* 2006 12/1;58(14):1471-504.
5. Rohrer M, Bauer H, Mintorovitch J, Requardt M, Weinmann HJ. Comparison of magnetic properties of MRI contrast media solutions at different magnetic field strengths. *Invest Radiol* 2005; 40(11):715-24.
6. Ouakssim A, Roch A, Pierart C, Muller RN. Characterization of polydisperse superparamagnetic particles by nuclear magnetic relaxation dispersion (NMRD) profiles. *Journal of Magnetism and Magnetic Materials* 2002 11; 252:49-52.
7. Wang YXJ, Hussain SM, Krestin GP. Superparamagnetic iron oxide contrast agents: Physicochemical characteristics and applications in MR imaging. *Eur Radiol* 2001; (11):2319-31.
8. Weissleder R, Stark DD, Engelstad BL, Bacon BR, Compton CC, White DL, Jacobs P, Lewis J. Superparamagnetic iron oxide: Pharmacokinetics and toxicity. *Am J Roentgenol* 1989;152(1):167-73.
9. Muller R.N., Vander Elst L, Roch A, Peters J.A, Csajbok E, Gillis P, Gossuin Y. Relaxation by metal-containing nanosystems. In: *Advances in inorganic chemistry. Academic Press; 2005.*
6th conference on Field Cycling NMR relaxometry - Turin, Italy 4-6 June 2009

An Integrated Overhauser-Prepolarized MRI Scanner

G Scott, K. Ahn, D. Kristov, J. Pauly, S. Conolly, P. Stang
Stanford University, Stanford CA

Introduction: Prepolarized MRI (PMRI) [1] and Overhauser MRI (OMRI) [2] or proton electron double resonance imaging (PEDRI) [3] share a common requirement for a precision pulsed homogeneous readout magnet. We present an extension to our PMRI scanner that allows EPR Overhauser enhancement at frequencies from 100 to 500 MHz, with proton readouts approaching 0.2T.

PMRI: Our existing PMRI scanner incorporates a pulsed readout magnet capable of operation to 0.2T with ramp-up times under 80 ms. The present configuration includes an inhomogeneous 0.3T knee size polarizing coil. During proton imaging, the readout and polarizer combine for a 0.5T B_0 to boost M_0 . All imaging gradients and FID detection occur after polarizer ramp-down at readout frequencies typically between 1 and 7 MHz. This system operates under the control of a custom USB scalable console, and is fully programmable in Matlab. Figure 1 shows the PMRI system that can deliver maximum 0.3 T polarizing field and 0.2 T readout field.

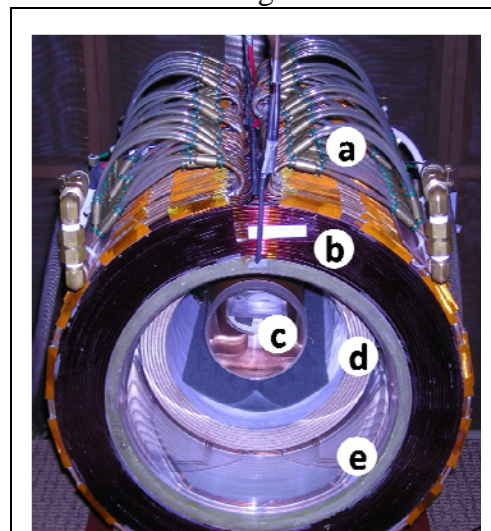

Figure 1: PMRI scanner (a) water cooling (b) 33-cm bore readout magnet (c) resonator (d) 20-cm bore polarizing magnet (e) 3-axis gradient coil set

EPR Enhancement: Instead of applying electromagnet prepolarization, we can instead field-cycle to a 5 – 10 mT readout to match one of the EPR lines. To test Overhauser enhancement, we constructed a 3.5 cm diameter saddle coil tuned for 186 MHz. We added RF gating to a PP100-500-100 100W 100-500 MHz amplifier (www.PMTRF.com) and a VHF signal source. EPR irradiation was also pulse sequence programmable with the MEDUSA (USB) console.

Phantom Test: In a first test, we stepped the readout field between 4.2mT and 9.4 mT during a 300ms EPR irradiation, and cycled to 2.2MHz for proton readout. Figure 2 shows the resulting EPR lines, for 2.5 mM PROXYL and proton enhancement over time. The Overhauser-enhanced spectrum shows three hyperfine lines of ^{14}N at 4.8, 6.2 and 8.1 mT. Figure 3 shows gradient-echo MR images (TR/TE 900 ms/17 ms, 52- mT readout field, 40W EPR 300ms) using Overhauser enhancement at the 4.8 mT nitroxide line.

Conclusion: The integrated Overhauser-PMRI system demonstrated sensitivity to both EPR and NMR. Compared to most OMRI systems, the higher readout should enable higher-quality anatomic EPR/NMR images. **References:** [1] Matter et al, MRM 56:1085, 2006. [2] Utsumi et al, PNAS 103:1463, 2006, [3] Lurie, MRI 23:173, 2005.

Conclusion: The integrated Overhauser-PMRI system demonstrated sensitivity to both EPR and NMR. Compared to most OMRI systems, the higher readout should enable higher-quality anatomic EPR/NMR images. **References:** [1] Matter et al, MRM 56:1085, 2006. [2] Utsumi et al, PNAS 103:1463, 2006, [3] Lurie, MRI 23:173, 2005.

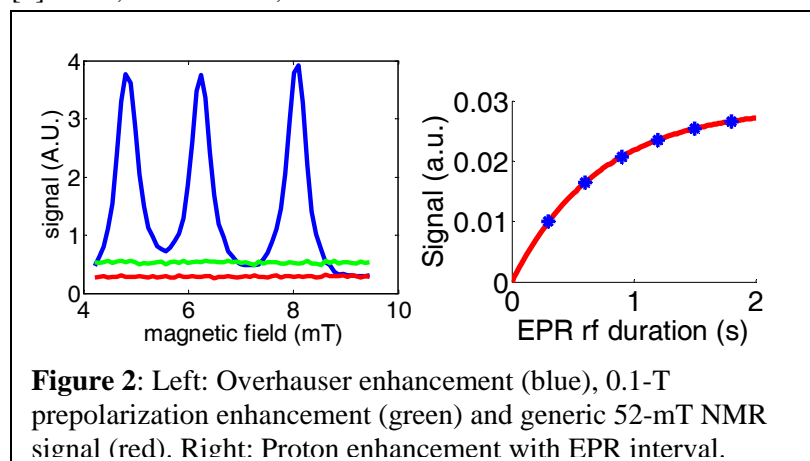

Figure 2: Left: Overhauser enhancement (blue), 0.1-T prepolarization enhancement (green) and generic 52-mT NMR signal (red). Right: Proton enhancement with EPR interval.

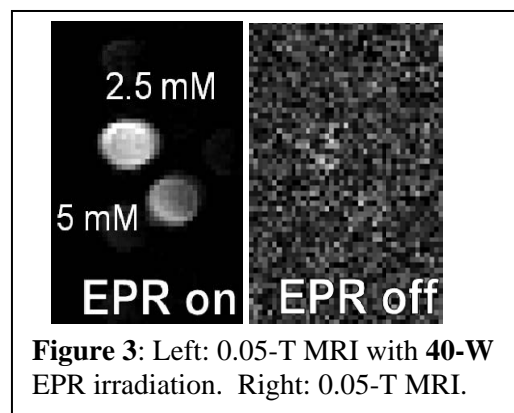

Figure 3: Left: 0.05-T MRI with 40-W EPR irradiation. Right: 0.05-T MRI.

Fast Field Cycling NMR Relaxometer: Evolution, Power and Features

Duarte Sousa¹ Gil Marques² José Manuel Cascais³ Pedro Sebastião⁴

^{1, 2, 3} DEEC AC-Energia/CIEEE, Instituto Superior Técnico, TULisbon – Av. Rovisco Pais – 1049-001 Lisboa – Portugal

⁴ Centro de Física da Matéria Condensada, Av. Prof. Gama Pinto 2, 1649-003 Lisboa, Portugal and TU Lisbon, IST/DF, Av. Rovisco Pais, 1049 - 001 Lisboa

¹duarte.sousa@ist.utl.pt, ²gil.marques@ist.utl.pt, ³cascaistrue@gmail.com, ⁴pedro.jose.sebastiao@ist.utl.pt

The development of FFC relaxometers has been done taking advantage of the evolution of power electronics and magnet design techniques [1-4]. The incorporation of new technologies in the FFC relaxometers has allowed for the availability of equipment with higher detecting magnetic fields or equipments with reduced size and less power consumption [5-6].

Three generations of FFC-NMR relaxometers, developed in the past years, with power supplies using IGBT (*Insulated gate bipolar transistor*) power semiconductors will be presented. Three different approaches were considered on the magnet's design, homogeneity, field strength, magnet's size. Last developments have allowed for the design of a small, low power consumption magnet for a desktop size FFC NMR relaxometer.

One interesting aspect of the developed work is that the working principles of the three topologies point out clearly the evolution and distinctive aspects of each relaxometer. Each new generation of FFC relaxometer includes additional features to widen the range of studies that are possible to. In particular, the most recent small size desktop FFC NMR relaxometer gives the possibility to perform FFC experiments with angular rotation of the sample in a direction perpendicular to the magnetic field, without the use of any additional magnetic field. This feature is particularly useful when studying oriented samples.

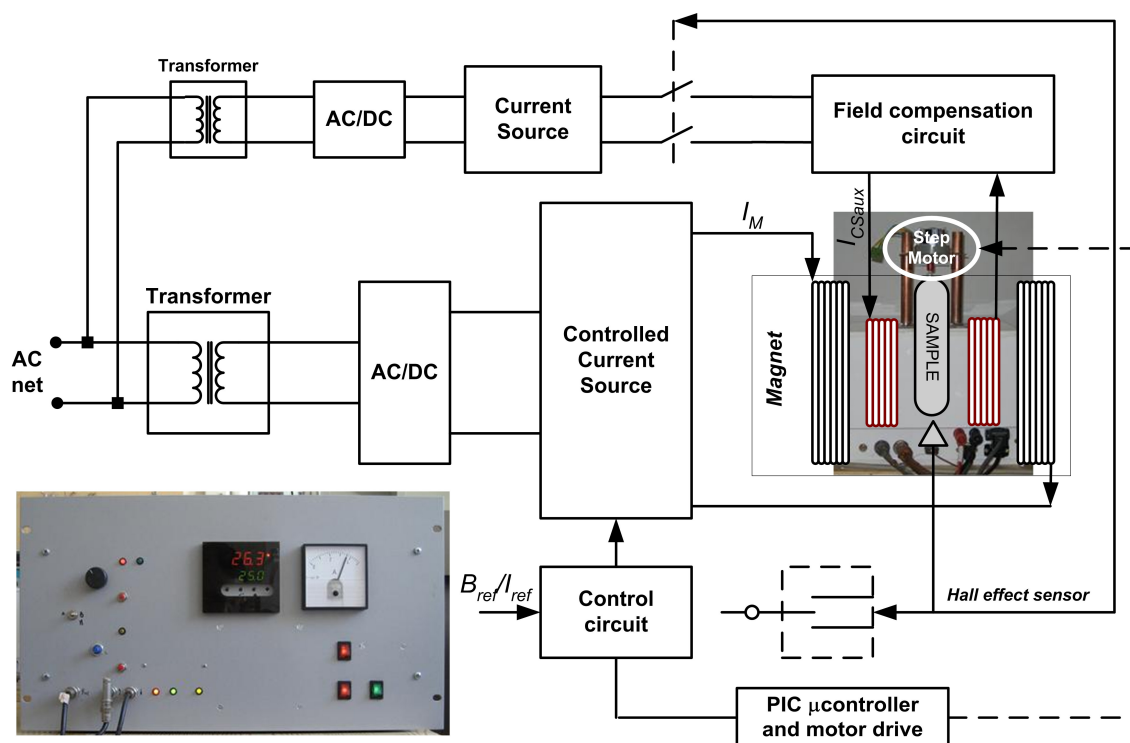

Figure 1 - Main blocks of the desktop FFC relaxometer

- [1] F. Noack, *Progress in NMR Spectroscopy*, Vol. 18, pp. 171-276, 1986
- [2] R.-O. Seitter, R. Kimmich, *Encyclopedia of Spectroscopy and Spectrometry*, pp. 2000-2008, London Academic Press, 1999
- [3] E. Anardo, G. Galli, G. Ferrante, *Appl. Magn. Reson.*, 20, pp. 365-404, 2001
- [4] R. Kimmich and E. Anardo, *Progress in NMR Spectroscopy*, 44, pp. 257-320, 2004
- [5] C. Job, J. Zajicek, M. F. Brown, *Review of Scientific Instruments*, 67 (6), pp. 2113-2122, 1996
- [6] D. M. Sousa, G. D. Marques, P. J. Sebastião, and A. C. Ribeiro, *Review of Scientific Instruments*, 74, No. 10, pp. 4521-4528, 2003

Method for the measurement of NMRD profiles of contrast agents in wide magnetic field range using clinical MRI scanner

G.Ferrante¹, B.Rutt², S. Aime³, S.Baroni⁴, A. Regge⁵ and S.Cirillo⁵

¹ Stelar s.r.l, Mede (PV) Italy

² Department of Radiology, Stanford University CA USA

³ Molecular Imaging Center, University of Turin, Italy

⁴ Invento s.r.l Turin - Italy

⁵ Institute for Cancer Research and Treatment, Turin, Italy

The dependence of $T_1(B)$ on the magnetic field B_0 is called T_1 dispersion curve or Nuclear Magnetic Relaxation Dispersion (NMRD) profile. The dispersion curves are potentially very powerful tools for the discrimination between various molecular dynamics models, in particular the design and characterization of contrast agents at the magnetic field of clinical MRI scanners.

In the poster we present the development of a concept and a compact NMR fast field cycling (FFC) instrumentation capable of acquiring an NMRD profile of a compound (contrast agent) in a field range of 0.5T (-0.25T + 0.25 T), centred around the magnetic field of any standard clinical MRI scanner.

The application emphasis is the characterization of MRI contrast agents, particularly in the study of variation of relaxivity around the "central" field strength, as defined by the MRI system magnet. The information obtained about the variation of relaxivity is useful for several reasons, including the general understanding of fundamental relaxation physics by constructing a continuous NMRD profile over some range of field strengths and creating novel imaging methods such as dreMR (delta relaxation enhanced MR), which requires knowledge of the variation or slope of relaxivity of the contrast agent around a specific central field value.

The poster includes illustrations of NMRD profiles obtained on commercial MRI contrast agents acquired at three different MRI fields: 0.2T, 1.5T and 3T. Of particular interest in the study is the MS235 in Human Serum Albumin (0.6mM) sample, which shows a relaxivity peak centred at 35-40MHz with a strong slope around 1.5T. MS235 is used as blood pool agent as it binds strongly to serum albumin.

Future improvements will be focused on the development of different magnet system with an higher field swing of +/- 0.5T or 0.75T to cover the full NMRD profile ranging from 0 to 2T or more with a 0.5T and 1.5 T MRI system magnet.



Fig. 1 NMR FFC instrument in a 1.5T MRI magnet

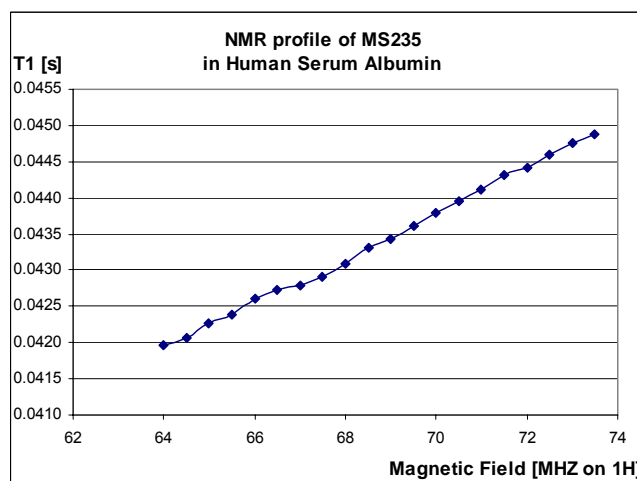

Fig. 2 NMRD profile of MS235 contrast agent in Human Serum Albumin

- [1] Helm L; Prog Nucl Magn Reson Spectrosc. 49: 4564 (2006)
 [2] Caravan P et al.; Inorg Chem. 46: 66326639 (2007)
 [3] Alford JK et al.; Magn Reson Med. 2009 Apr; 61(4):796-802

Acknowledgement:

Many thanks to Gregory Borisov, Matteo Polello and Luciano Dallochio for their important contribution in the construction of the instrument and Fabio Tedoldi for his assistance during the tests.

Paramagnetic liposomes as Enzyme-responsive Relaxometric agents

Sara Figueiredo^{a,b}, Enzo Terreno^b, João Nuno Moreira^c, Carlos F.G.C. Geraldes^a, Silvio Aime^b

a – Dep. of Biochemistry, Faculty of Sciences and Technology and Center for Neurosciences and Cell Biology, University of Coimbra, Portugal

b – Dep. of Chemistry IFM and Molecular Imaging Center, University of Turin, Italy

c – Lab. of Pharmaceutical Technology, Faculty of Pharmacy and Center for Neuroscience and Cell Biology, University of Coimbra, Portugal.

Assessment of a given enzymatic activity is an important task in Molecular Imaging investigations. When Magnetic Resonance is the imaging modality of choice it is necessary to design highly sensitive systems in order to overcome the relatively low sensitivity of this technique. Therefore we have envisaged an approach to enzyme-responsive agents based on the use of liposomes loaded with a high number of paramagnetic metal complexes. Liposomes are self-assembled vesicles formed by saturated and unsaturated phospholipids after used in drug delivery procedures. The contrast agent units (GdHPDO3A) have been loaded in the inner aqueous cavity of the liposome. The overall relaxation enhancement of solvent water protons depends upon the permeability of the liposome membrane to water molecules. The full release of the paramagnetic payload occurs with the disruption of the liposomal vesicle. Our work has addressed the objective of i) modifying the permeability of liposome membrane thus pursuing an enhancement of the observed proton relaxation rate upon the enzymatic cleavage of peptides covalently bounded to the phospholipid moieties or ii) promoting the disruption of low relaxivity aggregates formed by the binding capabilities of a macromolecular substrate that is selectively cleaved by the enzyme of interest.

As representative example of class i) systems a liposome containing a lipopeptide in its membrane will be reported. The peptide is cleaved by a specific MMP activity. In class ii) the activity of Hyaluronidase is assessed by using paramagnetic cationic liposomes covered by negatively charged, high molecular weight Hyaluronic Acid (HA).

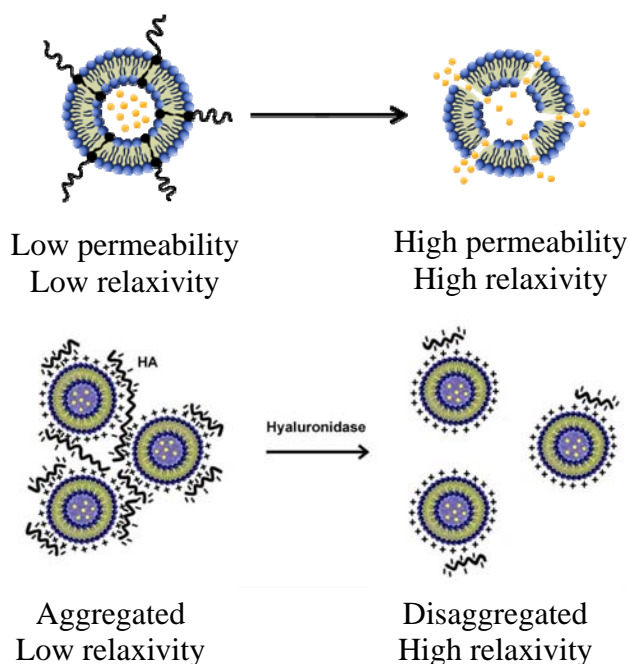

From high spin order to net ^{13}C magnetization using $^1\text{H}/^{13}\text{C}$ pulse sequence in a very low field NMR spectrometer (0.05T)

F. Reineri¹, S. Bubici², G. Ferrante³, M. Polello³, S. Ellena², S. Aime²

¹Univ. Of Torino, Dep. Chemistry IFM and Biotechnology Centre

²INVENTO srl, Turin, Italy

³STELAR srl, Mede, Italy

The possibility of using hyperpolarized ^{13}C or ^{15}N molecules as MRI contrast agents is currently under intense scrutiny as it has been anticipated that this methodology can make possible the quantitative visualization of metabolic processes.

Among the different methods currently used to achieve hyperpolarization of molecules of biological interest, ParaHydrogen Induced Polarization (PHIP) has the advantage of being cheaper and easy to use when compared to DNP and “brute force” approaches. In principle, it allows to achieve very high polarization levels provided that some conditions are satisfied. Besides the chemical requirements (easy hydrogenability of the substrate, high reaction yields etc.) other experimental features have to be matched. First of all, as the simple ^1H hyperpolarization cannot be used for in vivo MRI applications (because the very large water signal overcomes any other signal) it is necessary to set up the experimental workup in order to transfer the spin order of para-hydrogen nuclei into net ^{13}C or ^{15}N magnetization.. As the polarization is lost once the equilibrium population is restored, ^{13}C or ^{15}N resonances characterized by long relaxation times have to be selected.

Carbonylic group (^{13}CO) meets these requirements and unsaturated molecules bearing carbonyl moieties have become the candidate of choice for these applications. However the ^{13}C hyperpolarized signal that derives directly from parahydrogenation is an antiphase signal deriving from longitudinal two spin order ($I_z^{\text{H}}I_z^{\text{C}}$), whose net intensity is zero. As a consequence it cannot be used for acquiring MR images and it must be transformed into longitudinal magnetization (I_z^{C}).

To tackle this task, a low field (0.05T) dedicated $^1\text{H}/^{13}\text{C}$ NMR spectrometer has been developed. The parahydrogenation reaction can be carried out inside a wide-bore probe using an appropriate device. A pulse sequence [1] acting on ^1H and ^{13}C allows to turn the antiphase ^{13}C signal into net magnetization. The correct application of the pulse sequence requires the accurate calibration of ^1H and ^{13}C pulses. In particular the ^{13}C pulse calibration cannot be obtained using the thermal equilibrium ^{13}C signal, therefore an on-purpose field cycling method was used. The efficiency of the procedure has been tested using methyl 2-butynoate- d^6 as unsaturated substrate for the parahydrogenation reaction.

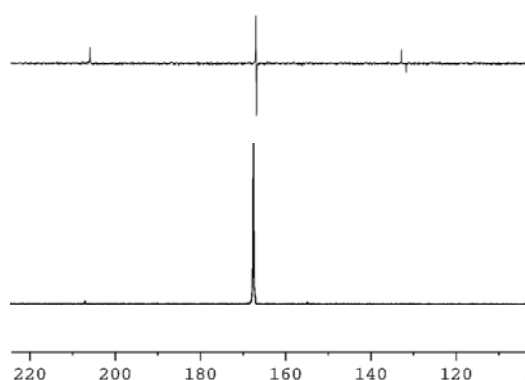

^{13}C polarized signal before the application of the pulse sequence (above): longitudinal spin order $I_z^{\text{H}}I_z^{\text{C}}$ is observed, net ^{13}C magnetization is zero. After the pulse sequence (below) longitudinal magnetization I_z^{C} is obtained.

[1] M.Goldman, H.Jöhanesson, C.R.Physique 6 (2005) 575-581

Hyperpolarization storage at earth field and zero field on parahydrogenated perdeuterated molecules

Francesca Reineri, Daniela Santelia, Roberto Gobetto, Silvio Aime
Univ. Of Torino, Dep. Chemistry IFM and Biotechnology Centre

Introduction

Hyperpolarization by means of DNP or parahydrogen is gathering increasing attention, due to potential applications of hyperpolarized molecules as MRI contrast agents.

However their use is strongly limited by polarization decay rate, which tends to restore the equilibrium population of spin levels in times dictated by the relaxation time constant T_1 . A brilliant method to achieve polarization lifetime much longer than T_1 has been introduced [1], which relies on the fact that transitions from singlet states are not allowed by selection rules. When this principle is applied in conjunction with PHIP, the two protons from parahydrogen can be maintained in the singlet state, even if they are added in chemically different sites, providing that the molecule is kept at low magnetic field. Furthermore parahydrogenation substrates often contain other protons, therefore the two parahydrogen protons are added to a more complex spin systems.

The use of perdeuterated molecules, such methyl 2-butynoate (**a**), allows to maintain the two spin system. As a consequence the polarization decay rate can be lowered providing that the magnetic field strength is low enough. We measured the polarization decay rates of parahydrogenated methyl 2-butynoate- d_6 (**b**) at earth field ($50 \mu\text{T}$) and zero field ($0.1 \mu\text{T}$) and compared them with the T_1 measured inside the spectrometer.

Results and discussion

The polarization decay rate of **b** at $50 \mu\text{T}$ was measured by reporting as a function of time the intensity of the ^1H polarized signals of parahydrogenated samples kept at earth magnetic field for time delays from 60 to 420 s (figure 1, left). In this case the relaxation time measured was 100 s, five times more than the T_1 measured using the inversion recovery pulse sequence with the molecule kept into the spectrometer (600 MHz for ^1H resonance).

This is in agreement with the fact that, even if the two protons are placed in chemically different sites, they resonate at the same Larmor frequency: this allows to maintain the singlet state.

The same procedure was repeated in order to measure the polarization decay rate at lower field ($0.1 \mu\text{T}$). In this case the parahydrogenated samples were kept into a μ -metal chamber for increasing time delays. In this condition the resonance frequencies of heteronuclei (in our case of ^1H and ^2H) become very close ($\Delta\nu_{\text{H-D}} \approx 3 \text{ Hz}$) and the spin states are changed. In this case the relaxation rate measured is higher than at earth field (42 s): this might be due to the fact that, at this field, quadrupolar relaxation can contribute to polarization decay.

Conclusions

Deuteration of parahydrogenation substrates can allow to keep the parahydrogen state on the product molecule, therefore to lengthen hyperpolarization lifetime. However, when deuterium nuclei are scalarly coupled with parahydrogen protons, magnetic field strength must be carefully chosen in order to avoid isotropic mixing between ^1H and ^2H .

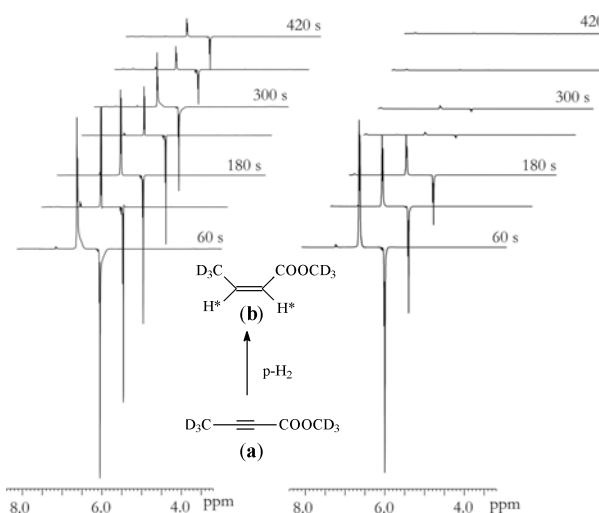

Figure 1: ^1H -NMR PHIP signals of (**b**) at increasing time intervals; the samples were kept at earth field ($50 \mu\text{T}$, left) and $0.1 \mu\text{T}$ (right).

[1] M.Carravetta, O.G.Johannessen and M.H.Levitt *Phys. Rev. Lett.* **92**, 153003 (2004)

Multivariate Analysis of T1 Relaxation Decays In Fast-Field-Cycling Data

Salvatore Bubici¹, Matteo Polello², Gianni Ferrante²

¹Invento srl, Turin, Italy, ²Stelar srl, Mede PV, Italy

The analysis of the nuclear magnetization decay is the base of low-resolution NMR.

In heterogeneous systems, due to a large number of micro-domains with a certain spin density having the same relaxation time, NMR T1 relaxation decay can be multi-exponential. The fitting process is an important element to derive amplitudes and time constants in relaxation-time analysis. Multi-exponential decay can be calculated using a non-linear least-squares regression of experimental data. On the other hand, when the decay constants have values close enough to each other, the system can be described by a continuous distribution. The NMR decay associated with a continuous distribution of relaxation constants is often described in the literature in terms of a Laplace transform, which if is inverted by computation give the distribution of relaxation time. Several algorithms and software packages can be found in literature for the numerical inversion of Laplace equation. One of the most successful regularization process applied to NMR relaxation data is UPEN [1, 2]. In this work, we performed a systematic analysis of UPEN using simulated and experimental data generation. We also reported 1H NMRD data analysis of a prepared ad-hoc phantom sample: two Gd(III) chloride solutions with different T1 relaxation time, inserted in concentric NMR tubes. Our aim was to obtain the profile of different components extracted from single signal decay. We used the model-free [3] approach to analyze such stretched dispersion profiles.

By comparing the different amplitudes, which are obtained by fitting process reported to the spin population at different fields, the analysis of data on FFC measures has shown some limitations.

We propose some procedures to overcome these limitations and to obtain quantitative information that allows a comparison at different fields.

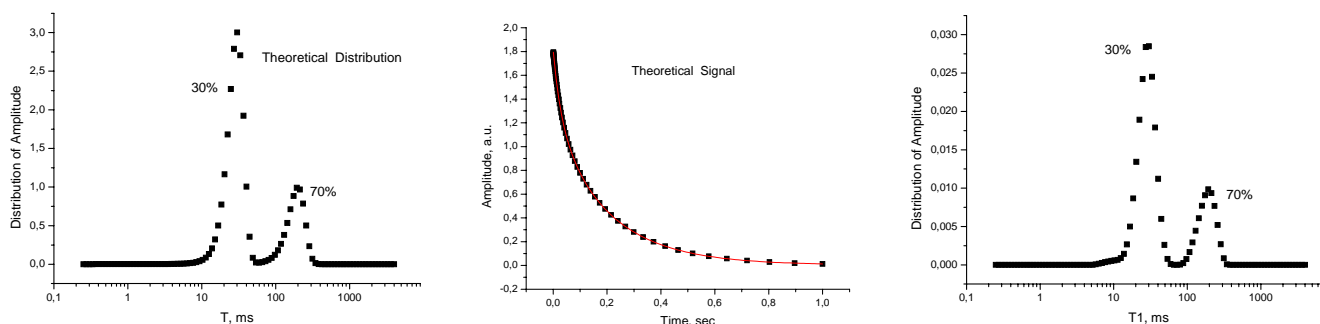

Theoretical distribution:

$$G(T) = 3 \cdot \exp\left\{-\frac{1}{2} \cdot \left[\frac{T-0.03}{0.007}\right]^2\right\} + \exp\left\{-\frac{1}{2} \cdot \left[\frac{T-0.2}{0.05}\right]^2\right\}$$

Theoretical Signal achieved by G(T)

Distribution function achieved by UPEN

The distributions are in a hybrid plot in sense that the distributions with respect to time are plotted against log-time: Equal areas no represent equal amounts of amplitude. Real percent of amplitude are indicated in the graphics.

[1] G. C. Borgia, R. J. S. Brown, and P. Fantazzini JOURNAL OF MAGNETIC RESONANCE 132, 65-77 (1998)

[2] G. C. Borgia, R. J. S. Brown, and P. Fantazzini Journal of Magnetic Resonance 147, 273-285 (2000)

[3] Bertil Halle, Haukur Johannesson, and Kandadai Venu, JOURNAL OF MAGNETIC RESONANCE 135, 1-13 (1998)

Bread staling is a complex phenomenon that originates from multiple physico-chemical events (including retrogradation of amylopectin, water loss and water molecular redistribution) and it is not yet completely understood. Much effort has been undertaken to understand bread staling on a molecular basis and low resolution NMR techniques have been reported to be a suitable technique. In particular, ^1H T_2 relaxation (20 or 23 MHz spectrometers) has been used in several studies to investigate mobility changing of baked products over storage (Engelsen et al., 2001; Chen et al., 1997; Sereno et al., 2007). These studies evidenced multiple ^1H T_2 populations in baked products that underwent major changes over storage, resulting in a reduced mobility in stored products.

Alternative ^1H NMR techniques, such as Field Cycling, can operate at different frequencies and allow observing mobility changes over a wider range of frequencies.

The aim of this study was, therefore, to evaluate proton mobility in white bread (flour: water ratio 100:58, yeast 3, sugar 4, seeds oil 3, salt 2) during 7 days of storage. A low resolution (20 MHz) ^1H NMR spectrometer (the miniSpec, Bruker Biospin, Milano, Italy) operating at 25°C was used to measure the free induction decay (FID), transverse (T_2) and longitudinal (T_1) relaxation times. A Field Cycling Spectrometer (Stelar Srl, Mede PV, Italy), was used to acquire ^1H T_1 relaxation times at variable frequency (0.01, 0.027, 0.072, 0.193, 0.520, 1.390, 3.730 and 10 MHz).

The fast relaxing portion of FID curves (0.0074 - 0.08 ms), indicative of a very rigid ^1H population, was found to decay faster with increasing storage, indicating increased rigidity that was previously associated to reduced mobility of the bread matrix due to both recrystallizing amylopectin and loss of water (Sereno, et al., 2007). Proton T_2 and T_1 relaxation decays were analyzed as quasi-continuous distributions of relaxation times using the UPEN software (Borgia et al. 1998, Borgia et al. 2000). Three ^1H T_2 populations were found: the fastest population (A) relaxed at 0.15 ms (T_{2A}), the intermediate (B) at 9-12 ms (T_{2B}) and the more mobile (C) at times higher than 100 ms (T_{2c}). The major changes observed during storage showed a significant decrease of population A (from 27 to 21%) and an increase of population B (63 to 68%), while population C remained constant over storage time. T_{2A} and T_{2c} didn't show relevant changes during storage while T_{2B} slightly decreased (from 12 ms to 9.5 ms).

^1H T_1 distributions indicated the presence of one population at all frequencies investigated. ^1H T_1 relaxation times decreased with decreasing frequency (e.g. ^1H T_1 = 100 ms at 20 MHz and ^1H T_1 = 7 ms at 0.01 MHz). ^1H T_1 relaxation rate (R_1 , s^{-1}) was also found to increase with increasing storage time at all frequencies, more evidently at frequencies lower than 0.2 MHz (e.g. $R_{1(0.07\text{ MHz})} = 87\text{ s}^{-1}$ at 0 days and $R_{1(0.07\text{ MHz})} = 93\text{ s}^{-1}$ at 7 days) while it was not significant at higher frequencies (e.g. $R_{1(20\text{ MHz})} = 0.009\text{ s}^{-1}$ at 0 days and $R_{1(20\text{ MHz})} = 0.01\text{ s}^{-1}$ at 7 days).

Bread staling has been investigated at a molecular level in this study and ^1H NMR techniques operating at lower frequencies have underlined mobility changes that are not well detectable with a 20MHz spectrometer. NMR techniques operating at different magnetic fields may be suitable to better understand the molecular phenomena occurring in bread staling.

References

- Borgia G.C., Brown R.J.S. & Fantazzini P. (1998). Uniform-Penalty Inversion of Multiexponential Decay Data. *Journal of Magnetic Resonance*, 132, 65-77.
- Borgia G.C., Brown R.J.S. & Fantazzini P. (2000). Uniform-Penalty Inversion of Multiexponential Decay Data II. Data Spacing, T_2 Data, Systematic Data Errors, and Diagnostics. *Journal of Magnetic Resonance*, 147, 273-285.
- Chen, P.L., Long, Z., Ruan, R. & Labuza, T.P. (1997). Nuclear magnetic resonance studies of water mobility in bread during storage. *Lebensmittel-Wissenschaft und-Technologie*, 30 (2), 178-183.
- Engelsen, S.B., Jensen, M.K., Pedersen, H.T., Norgaard, L. & Munck, L. (2001). NMR-baking and multivariate prediction of instrumental texture parameters in bread. *Journal of Cereal Science*, 33 (1), 59-67.
- Sereno, N.M., Hill, S.E., Mitchell, J.R., Scharf, U. & Farhat, I.A. (2007). Probing water migration and mobility during the aging of bread. In Farhat, I.A., Belton, P.S., & Webb, G.A. (Eds), *Magnetic Resonance in Food Science: From Molecules to Man..* Nottingham 16-19 July 2006, (pp. 89-95), UK: RSC Publishing.

Relaxometric Investigations on Mn(II) containing Liposomes

S. Baroni¹, G.Ferrante², S.Aime³

¹*Invento S.r.l., c/o2I3T Incubator, University of Torino, Via Nizza 52, I-10126, Torino, Italy*

²*Stelar S.r.l., Via Fermi 4, I-27035, Mede (PV), Italy*

³*Molecular Biotechnology Center and Department of Chemistry I.F.M., University of Torino, Via Nizza 52, I-10126 Torino, Italy*

In order to overcome the sensitivity problems encountered in MR Molecular Imaging applications it is necessary to accumulate a high number of Contrast Agent (CA) units at the targeting site. This task may be tackled by entrapping paramagnetic complexes into nano-sized carriers [1]. Herein we report our recent work aimed at exploring routes to high sensitivity MRI agents based on the entrapment of Mn(II)-aquo ions in liposomes.

Liposomes are vesicles of 100-200 nm diameter formed by self-assembling of phospholipids and cholesterol. By carrying out the hydration of the lipidic film in the presence of MnCl₂, it is possible to entrap the paramagnetic ions in the aqueous cavity of the liposomes. The liposomes membrane is permeable to water molecules thus allowing the paramagnetic effect to be transferred to the “bulk” solvent molecules. The acquisition of the NMRD profiles over an extended range of magnetic field strengths has made possible to get more insight into the determinants of the observed relaxivities. The analysis of the obtained data has allowed us to establish the occurrence of a binding interaction between the Mn(II) ions and the phosphate head groups facing the surface of the inner liposomal cavity. The fast exchange between free and bound forms makes the observed relaxation enhancement markedly dependent on the temperature and on the concentration of Mn(II) ions in the inner cavity.

The overall behavior of the NMRD profile makes these systems interesting candidates for the developments of CAs for Field Cycling MRI [2].

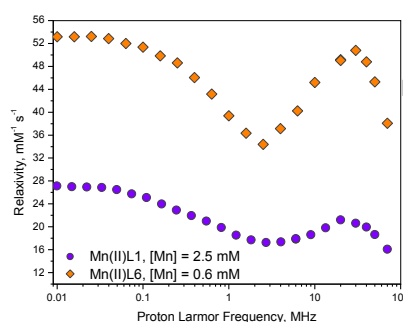
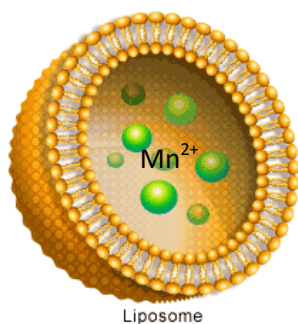

NMRD profiles of Mn(II) containing Liposomes. [Mn(II)] determined in the suspension, after liposome destruction.

[1] E Terreno *et al.* (2008) *Chemistry & Biodiversity* 5, 1901-1912

[2] DJ Lurie *et al.* (1998) *Phys Med Biol* 43, 1877-188

Relaxometric Characterization of Balsamic Vinegar

S. Baroni[†], R. Consonni[‡], G. Ferrante[#], S. Aime⁺

[†] *Invento S.r.l., spin off dell'Università di Torino, Via Nizza 52, 10126, Torino, Italy*

[‡] *Istituto per lo Studio delle MACromolecole (ISMAC), Laboratorio NMR, CNR, Via Bassini 15, 20133 Milano, Italy*

[#] *Stelar S.r.l., Via Fermi 4, 27035 Mede (PV), Italy*

⁺ *Dipartimento di Chimica I.F.M., Università di Torino, Via Pietro Giuria 7, 10125 Torino, Italy*

In the last few years, Traditional Balsamic Vinegar (TBVM) and Balsamic Vinegar of Modena (BVM) has received a great attention from different research groups, mainly aimed at focusing through NMR studies, the characterization of ageing process and fraud detection.

The aim of this work is to demonstrate the ability of Field Cycling Relaxometry to provide an in-depth characterization of both TBVM and BVM.

8 BVM and 7 TBVM samples were analyzed; 4 suspected counterfeit TBVM samples were also investigated. 1H-NMRD (Nuclear Magnetic Relaxation Dispersion) profiles were recorded by measuring water proton longitudinal relaxation rates (T1) at magnetic field strengths in the range from 0.01 to 80 MHz proton Larmor frequencies. In addition, water proton transversal relaxation rates (T2) were recorded.

The ageing process experienced by the samples, in particular by TBVM samples, is mostly characterized by water loss and progressively larger polysaccharide containing macromolecules formation that affected both T1 and T2 values. In general, very useful insights can be gained from the frequency dependent hump that occurs in the high field region of the NMRD profile. We assign this hump to the occurrence of slowly moving paramagnetic macromolecular adduct whose size increase with ageing (as bacterial activity result). The center of this hump (or well its width) depends on its size as the dispersion is controlled by the molecular reorientational time. Clearly this hump may also be generated by adding Arabic gum or caramel to young vinegar but the overall shape of the resulting profile does not fit with those of the genuine specimens.

In summary, we think that the NMRD profile acquisition can be of high potential to recognize fraudulent products as well as to provide an excellent fingerprint for the genuine specimens.

List of Participants

Silvio Aime

Moplecular Biotechnology Center
Via Nizza, 52
Torino
Italy
+39 011 6706451
silvio.aime@unito.it

Giuseppe Alonzo

Univ.Palermo dip. ITAF
Viale delle Scienze
Palermo
Italy
091-728171
alonzo@unipa.it

Houshang Amiri Doumari

Istituto Fisiologia Genrale
Via Trentacoste 2
Milan
Italy
3891956682
Amiri@fisicavolta.unipv.it

Esteban Anorado

FaMAF UNC
Medina Allende y Haya de la To
Cordoba
Argentina
54-351-4334051
anoardo@famaf.unc.edu.ar

Tomaz Apih

J Stefan Institute
Jamova 39
Ljubljana
+386 1 4773182
Slovenia
tomaz.apih@ijs.si

Ioan Ardelean

Technical University from Cluj
C. Daicoviciu 15
Cluj-Napoca
Romania
743347176
ioan.ardelean@phys.utcluj.ro

Santhosh Ayalur Karunakaran

TU Ilmenau
UnterpÄrrlitzer StraÃŸe 38
Ilmenau
Germany
492418026446
sayalur@mc.rwth-aachen.de

Simona Baroni

Molecular biotechnology Center
Via Nizza, 52
Torino
Italy
+39 011 6706496
simona.baroni@invento-lab.com

MichaÅ, Bielejewski

Institute of Molecula Physics
M. Smoluchowskiiego 17
Poznan
Poland
+48-061 8695-226
bielejewski@ifmpan.poznan.pl

Sabine Bouguet-Bonnet

Methodologie RMN
Vandoeuvre les Nancy
France
+33 3 83 68 43 48
Sabine.Bonnet@rmn.uhp-nancy.fr

Lionel Broche

Bio-Medical Physics
Foresterhill
Aberdeen
UK
441224553206
l.broche@abdn.ac.uk

Dermot Brougham

School of chemical Sciences
Glasnevin 9
Dubliin
Ireland
35317005472
dermot.brougham@dcu.ie

Robert Bryant

Chemistry Dept.
University of Charlottesville
P.O. Box 400319
Charlottesville Va
USA
1-434-924-3567
rgb4g@virginia.edu

Marina Carravetta

Univeristy of Southapton
University Road
Southampton
UK
M.Carravetta@soton.ac.uk

Houria Chemmi

Ecole Polytechnique CNRS
Route de Saclay
Palaiseau
France
33 1 69 33 46 72
hch@pmc.polytechnique.fr

Changhoon Choi

Bio-Medical Physics
Foresterhill
Aberdeen
UK
441224553489
changhoon.choi@abdn.ac.uk

Pellegrino Conte

Univ.Palermo dip. ITAF
Viale delle Scienze
Palermo
Italy
091-728171
pellegrino.conte@unipa.it

Gareth Davies

Bio-Medical Physics
Foresterhill Aberdeen
UK
441224553489
g.davies@abdn.ac.uk

Claudio De Pasquale

Univ.Palermo dip. ITAF
Viale delle Scienze
Palermo
Italy
091-728171
c.depasquale@unipa.it

Valentina Domenici

Dip.Chimica
Via Risorgimento 35
Pisa
Italy
0039 050 2219 266
valentin@dcc.i.unipi.it

Charles Eads

Procter & Gamble
8700 S. Mason-Montgomery Rd.
Mason, OH
USA
513 6225424
eads.cd@pg.com

Nail Fatkullin

Kazan State University
kremlevskaya 18
Kazan- Russia
nail.fatkullin@ksu.ru

Nazario Felix

Grupo de Bioinegnieria y Telem
Madrid
Spain
34-915 49 57 00 ext. 3322
nazariofelix@hotmail.com

Gianni Ferrante

Stelar srl
Via Enrico Fermi, 4
Mede
Italy
0384-820096
ferrante@stelar.it

Pascal H. Fries

CEA
17, rue des Martyrs
Grenoble
France
+33 4 38783107
pascal-h.fries@cea.fr

Anton GradiÅjek

J Stefan Institute
Jamova 39
Ljubljana
Slovenia
+386 31 401 455
anton.gradisek@ijs.si

HÅŸkan Gustafsson

Linkoping University
Linkoping
SWEDEN
+46 (0)13221475
hakan.l.gustafsson@liu.se

Bertil Halle

Lund University
Box 124
Lund
SWEDEN
+46 46 2229516
bertil.halle@bpc.lu.se

Lothar Helm

EPFL-SB-ISIC-LCIB
Lausanne
Switzerland
+41 21 693 9876
lothar.helm@epfl.ch

Axel Herrmann

Bayreuth University
Universitaetsstr. 30
Bayreuth
Germany
+49 921 552602
axel.herrmann@uni-bayreuth.de

Uvo Hoelscher

Magnetic Resonance Bavaria
Am Hubland
Wuerzburg
Germany
0049 931319 3066
hoelscher@mr-bavaria.de

Tony Horsewill

School of Physics & Astronomy,
University Park
Nottingham
UK
+44(0)115 9515141
a.horsewill@nottingham.ac.uk

Martin Hurlimann

Scumberger-Doll
One Hampshire Street
Cambridge
USA
hurlimann@slb.com

Saadiya Ismail

Bio-Medical Physics
Foresterhill
Aberdeen
UK
441224553206
saadiya.ismail@abdn.ac.uk

Konstantin Ivanov

International Tomography Centre
Institutskaya 3a
Novosibirsk
Russia
+7(383)333-3861
ivanov@tomo.nsc.ru

Rainer Kimmich

Albert Allee, 11
Ulm
Germany
+49-731-22408
rainer.kimmich@uni-ulm.de

Jean-pierre Korb

Lab PMC Ecole Polytechnique
Route de Saclay
Palaiseau
France
33 1 69 33 47 39
jean-pierre.korb@polytechnique

Danuta Kruk

Institute of Physics, Jagiellonian
Reymonta 4
Krakow
Poland
+48 12 663 5688
danuta.kruk@uj.edu.pl

Pierre Levitz

Ecole Polytechnique
Route de Palaiseau
PALAISEAU
FRANCE
33 01 69 47 27
pierre.levitz@polytechnique.edu

Steffen Lothar

Universitaet Wuerzburg Physik
Am Hubland
Wuerzburg
Germany
0049931 8884918
steffen.lothar@physik.uni-wuer

David Lurie

Bio-Medical Physics
Foresterhill
Aberdeen
UK
441224554061
d.lurie@abdn.ac.uk

Michael T. MacMahon

Johns Hopkins University
Baltimore
USA
mcmahon@mri.jhu.edu

M. Mariani

Dipartimento di Fisica "A. Volta"
Università di Pavia
Via Bassi 6
PAVIA
ITALY
390382987563
mariani@fiscavolta.unipv.it

Carlos Mattea

Institute of Physics, Technica
Unterpoerlitzer Strasse 38
Ilmenau
Germany
+49 3677 69 3674
carlos.mattea@tu-ilmenau.de

Wojciech Medycki

Institute of Molecular Physics
Smoluchowskiego 17
Poznan
Poland
00 48 618 695 100
wom@ifmpan.poznan.pl

Dara O Hogain

Bio-Medical Physics,
Foresterhill
Aberdeen
UK
441224553199
r01do7@abdn.ac.uk

Erik Persson

Lund University
Getingevägen 60
Lund
Sweden
46737204246
erik.persson@bpc.lu.se

Dominique Petit

Lab PMC Ecole Polytechnique
Route de Saclay
Palaiseau
France
33169334655
dpe@pmc.polytechnique.fr

Narczyz PiÅlewski

Institute of Molecular Physics
M. Smoluchowskiego 17
Poznan
Poland
+48-061 8695-226
narczyz.pislewski@ifmpan.poznan

Kerrin Pine

Bio-Medical Physics, Universitatat
Foresterhill
Aberdeen
UK
441224553199
k.pine@abdn.ac.uk

Janez Pirnat

Inst. of Math., Physics
Jadranska 19 (P.O.B.2964)
Ljubljana
Slovenia
+386 1 2517281
janez.pirnat@fmf.uni-lj.si

Matteo Polello

Stelar srl
Viai Enrico Fermi, 4
Mede
Italy
0384-820096
polello@stelar.it

Johan Qvist

Lund University
Box 124
Lund
Sweden
46462229595
johan.qvist@bpc.lu.se

Ernst Roessler

Experimentalphysik II,
Universitaetsstr. 30
Bayreuth
Germany
0049 0921 552618
ernst.roessler@uni-bayreuth.de

Brian Rutt

Stanford University
1201 Welch Road
Stanford
USA
(650) 721 6230
brutt@stanford.edu

Bubici Salvatore

Invento srl
Via Nizza, 52
Torino
Italy
+39 011 6706496
salvatore.bubici@invento-lab.com

Greig Scott

Stanford University
Stanford
Usa
650 724 3639
greig@mrsrl.stanford.edu

Pedro Sebastiao

CFMC-UL
Av. Prof. Gama Pinto 2
Lisboa
Portugal
+351 217904754
pedro.jose.sebastiao@ist.utl.p

Janez Seliger

Jozef Stefan" Institute
Jamova 39
Ljubljana
Slovenia
386 1 4773581
janez.seliger@ijs.si

Duarte Sousa

Instituto Superior TÁ©cnico/TU
Av. Rovisco Pais, 1
Lisbona
Portugal
351-218417429
duarte.sousa@ist.utl.pt

Tobias Sparrman

Department of Chemistry
UmeÅ¥ University
UmeÅ¥
Sweden
46907865370
tobias.sparrman@chem.umu.se

Siegfried Stapf

TU Ilmenau
PO Box 100 565
Ilmenau
Germany
493677693671
siegfried.stapf@tu-ilmenau.de

Emilie Steiner

Methodologie RMN,
Nancy-University
Vandoeuvre les Nancy
France
+33 3 83 68 43 48
Emilie.Steiner@rmn.uhp-nancy.fr

Richard Stevens

Molecular Specialties, Inc
10437 Innovation Drive, Suite
301
Milwaukee-WI-
Usa
(414) 258-6724
rich.stevens@molspec.com

Stanislav Sykora

Extra Byte
Via Raffaello Sanzio 22c
Castano Primo
Italy
+39 0331 880281
sykora@ebyte.it

Kalaivani Thangavel

UniveristÀ degli studi di Milano
Via Trentacoste 2
Milan
Italy
0039 0250315812
tkalaivani@gmail.com

Jadwiga Tritt-Goc

Institute of Molecular Physics
M. Smoluchowskiego 17
Poznan
Poland
+48-061 8695-226
jtg@ifmpan.poznan.pl

Luce Vander Elst

University of Mons
Avenue du champ de mars,24
MONS
Belgium
3265373518
luce.vanderelst@umons.ac.be

Hans Martin Vieth

Freie Universitaet Berlin
Arnimallee 14
Berlin
Germany
+49 30 83855062
hans-martin.vieth@physik.fu-be

Per-Olof Westlund

Chemistry-UmeÅ¥ University KBC
901 87 UmeÅ¥
UmeÅ¥
Sweden
+469078663 44
per-olof.westlund@chem.umu.se

Alexandra Yurkovskaya

Freie Universitaet Berlin
Arnimallee 14
Berlin
Germany
49-30-83856164
yurkov@physik.fu-berlin.de

Klaus Zick

Bruker BioSpin GmbH
Silberstreifen 4
Rheinstetten
Germany
4972151616135
klaus.zick@bruker-biospin.de

Lukasz Zielinski

Schlumberger-Doll Research
31 Ivaloo Street
Somerville
USA
2034175055
lzielinski@slb.com